

TABLE OF CONTENTS

Styles and Grades listed by Finish Options

GALVA-GUARD I

| | | |
|--------------------------------|----------------------|--------------------|
| <i>LIGHT REGAL,</i> | <i>Galva-Guard I</i> | <i>Pages 2-3</i> |
| <i>HEAVY REGAL,</i> | <i>Galva-Guard I</i> | <i>Pages 4-7</i> |
| <i>LIGHT ARISTOCRAT,</i> | <i>Galva-Guard I</i> | <i>Pages 8-9</i> |
| <i>HEAVY ARISTOCRAT,</i> | <i>Galva-Guard I</i> | <i>Pages 10-13</i> |
| <i>HEAVY GUARDIAN,</i> | <i>Galva-Guard I</i> | <i>Pages 14-17</i> |

POWDER COATED

| | | |
|--------------------------------------|--------------------|----------------|
| <i>LIGHT REGAL, Biasable</i> | <i>Powder Coat</i> | <i>Page 18</i> |
| <i>LIGHT ARISTOCRAT, Posts</i> | <i>Powder Coat</i> | <i>Page 19</i> |

TWO COAT ENAMEL

| | | |
|--------------------------------|-----------------|--------------------|
| <i>LIGHT REGAL,</i> | <i>Two Coat</i> | <i>Pages 20-21</i> |
| <i>HEAVY REGAL,</i> | <i>Two Coat</i> | <i>Pages 22-25</i> |
| <i>LIGHT ARISTOCRAT,</i> | <i>Two Coat</i> | <i>Pages 26-27</i> |
| <i>HEAVY ARISTOCRAT,</i> | <i>Two Coat</i> | <i>Pages 28-31</i> |
| <i>HEAVY GUARDIAN,</i> | <i>Two Coat</i> | <i>Pages 32-35</i> |
| <i>LIGHT EMPIRE,</i> | <i>Two Coat</i> | <i>Pages 36-37</i> |
| <i>LIGHT MODERN,</i> | <i>Two Coat</i> | <i>Pages 38-39</i> |
| <i>LIGHT NAPOLEON,</i> | <i>Two Coat</i> | <i>Pages 40-41</i> |

ONE COAT ENAMEL

| | | |
|------------------------------------|-----------------|--------------------|
| <i>LIGHT REGAL,</i> | <i>One Coat</i> | <i>Pages 42-43</i> |
| <i>LIGHT ARISTOCRAT,</i> | <i>One Coat</i> | <i>Pages 44-45</i> |
| <i>LIGHT EMPIRE,</i> | <i>One Coat</i> | <i>Pages 46-47</i> |
| <i>LIGHT MODERN,</i> | <i>One Coat</i> | <i>Pages 48-49</i> |
| <i>LIGHT REGAL Biasable,</i> | <i>One Coat</i> | <i>Page 50</i> |

| | |
|-------------------------|----------------|
| TRASH ENCLOSURE | <i>Page 51</i> |
| CANTILEVER GATES | <i>Page 52</i> |

PICKET POSITION

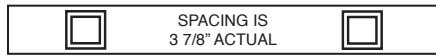

- 1" Square Top & Bottom Rail, 16 ga.
- 5/8" Square Pickets, 18 ga.
- 4" (3 7/8" actual) Spacing between Pickets
- Tubing Galvanized before Fabrication
- Power Washed for Paint Preparation
- One Spray Coat High Solids Primer
- One Spray Coat Polyurethane Black
- Custom Colors Available at Additional Cost
- Choose from 14 Standard Colors — add 5%

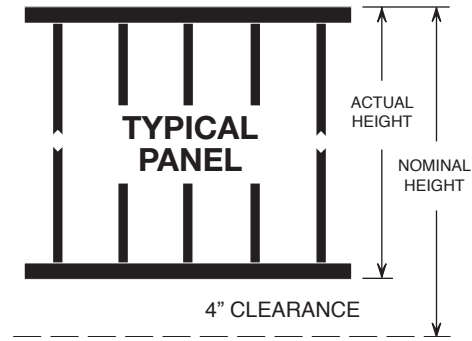

LIGHT REGAL, Galva-Guard I, Conventional sizes

PRE-GALVANIZED TUBING & POLYURETHANE PAINTED

Panels

| | Nominal Height Actual Height | 3' 32" | 3 1/2' 38" | 4' 44" | 5' 56" | SPECIAL 58" | 6' 68" |
|------------------------|---------------------------------|-----------|---------------|-----------|-----------|----------------|-----------|
| 94" length | Item Number | 68010-GI | 68040-GI | 68110-GI | 68210-GI | 68211-GI | 68310-GI |
| | Weight in Pounds | 33 | 37 | 41 | 49 | 53 | 57 |
| 120" length | Item Number | 68020-GI | 68050-GI | 68120-GI | 68220-GI | 68221-GI | 68320-GI |
| | Weight in Pounds | 42 | 47 | 52 | 62 | 64 | 72 |
| 143 1/2" length | Item Number | 68030-GI | 68060-GI | 68130-GI | 68230-GI | 68231-GI | 68330-GI |
| | Weight in Pounds | 50 | 56 | 62 | 74 | 76 | 86 |

Single Gates

Includes zinc plated standard hardware: an "A-Kit" and an "M-Kit"

| | Nominal Height Actual Height | 3' 32" | 3 1/2' 38" | 4' 44" | 5' 56" | SPECIAL 58" | 6' 68" |
|-------------------|---------------------------------|-----------|---------------|-----------|-----------|----------------|-----------|
| 3' opening | Item Number | 68409-GI | 68414-GI | 68419-GI | 68429-GI | 68421-GI | 68439-GI |
| | Weight in Pounds | 16 | 18 | 20 | 24 | 25 | 29 |
| 4' opening | Item Number | 68410-GI | 68415-GI | 68420-GI | 68430-GI | 68431-GI | 68440-GI |
| | Weight in Pounds | 19 | 22 | 24 | 29 | 30 | 34 |

Double Gates

Includes zinc plated standard hardware: 2 "A-Kits" and an "R5-Kit"

| | Nominal Height Actual Height | 3' 32" | 3 1/2' 38" | 4' 44" | 5' 56" | SPECIAL 58" | 6' 68" |
|--------------------|---------------------------------|-----------|---------------|-----------|-----------|----------------|-----------|
| 10' opening | Item Number | 68449-GI | 68454-GI | 68459-GI | 68469-GI | 68461-GI | 68479-GI |
| | Weight in Pounds | 49 | 55 | 62 | 75 | 76 | 88 |
| 12' opening | Item Number | 68450-GI | 68455-GI | 68460-GI | 68470-GI | 68471-GI | 68480-GI |
| | Weight in Pounds | 56 | 63 | 70 | 84 | 85 | 98 |

BFC Ornamental Iron

LIGHT REGAL
Galva-Guard I

LIGHT REGAL, Galva-Guard I, Non-Conventional Sizes

PANELS • Item # 68000-GI

To determine prices for non-standard sizes, use this list of "per foot" prices.

| | | HEIGHT | | | | | | | |
|----------|-----|--------|----|--------|----|----|----|----|----|
| | | 2' | 3' | 3 1/2' | 4' | 5' | 6' | 7' | 8' |
| per foot | -XX | | | | | | | | |

SINGLE GATES • Item # 68400-GI

Single Gates include zinc plated standard hardware: an "A-kit" and an "M-kit".

| | | HEIGHT | | | | | | | |
|-------|-----|--------|----|--------|----|----|----|----|----|
| | | 2' | 3' | 3 1/2' | 4' | 5' | 6' | 7' | 8' |
| WIDTH | 3' | | | | | | | | |
| | 4' | | | | | | | | |
| | 5' | | | | | | | | |
| | 6' | | | | | | | | |
| | 7' | | | | | | | | |
| | 8' | | | | | | | | |
| | 9' | | | | | | | | |
| | 10' | | | | | | | | |

DOUBLE GATES • Item # 68455-GI

Double Gates include zinc plated standard hardware: 2 "A-kits" and an "R5-kit".

| | | HEIGHT | | | | | | | |
|-------|-----|--------|----|--------|----|----|----|----|----|
| | | 2' | 3' | 3 1/2' | 4' | 5' | 6' | 7' | 8' |
| WIDTH | 6' | | | | | | | | |
| | 8' | | | | | | | | |
| | 10' | | | | | | | | |
| | 12' | | | | | | | | |
| | 14' | | | | | | | | |
| | 16' | | | | | | | | |
| | 18' | | | | | | | | |
| | 20' | | | | | | | | |

Prices are for rectangular fence and gates only.
For BIAS fence and gates, add \$ per lineal foot.
For TAPERED fence and gates, add \$ per lineal foot.

FOR CUSTOM OPTIONS: arching, scroll work or a wide variety of design alternatives, see the **SPECIAL PRICING APPLICATIONS** section of this catalog.

PICKET POSITION

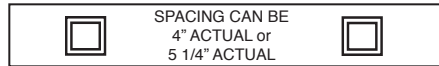

- 1 1/2" Square Top & Bottom Rail, 14 ga.
- 3/4" Square Pickets, 16 ga.
- 4" or 5 1/4" Spacing between Pickets
- Tubing Galvanized before Fabrication
- Power Washed for Paint Preparation
- One Spray Coat High Solids Primer
- One Spray Coat Polyurethane Black
- Custom Colors Available at Additional Cost
- Choose from 14 Standard Colors — add 5%

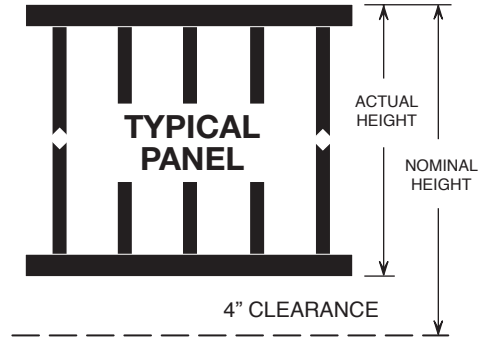

HEAVY REGAL, Galva-Guard I, Conventional sizes PRE-GALVANIZED TUBING & POLYURETHANE PAINTED

Panels, Conventional Sizes, 4" PICKET SPACING

| | Nominal Height | 5' | 6' | 7' | 8' |
|------------------------|------------------|----------|----------|----------|----------|
| 94" length | Item Number | 79010-GI | 79020-GI | 79030-GI | 79040-GI |
| | Weight in Pounds | 74.4 | 86.4 | 97.6 | 109.6 |
| | Price | | | | |
| 118" length | Item Number | 79012-GI | 79022-GI | 79032-GI | 79042-GI |
| | Weight in Pounds | 93 | 108 | 122 | 137 |
| | Price | | | | |
| 141 3/4" length | Item Number | 79014-GI | 79024-GI | 79034-GI | 79044-GI |
| | Weight in Pounds | 111.6 | 129.6 | 146.4 | 164.4 |
| | Price | | | | |

Panels, Conventional Sizes, 5 1/4" PICKET SPACING

| | Nominal Height | 5' | 6' | 7' | 8' |
|------------------------|------------------|----------|----------|----------|----------|
| 94" length | Item Number | 79110-GI | 79120-GI | 79130-GI | 79140-GI |
| | Weight in Pounds | 61.6 | 70.4 | 78.4 | 88 |
| | Price | | | | |
| 118" length | Item Number | 79112-GI | 79122-GI | 79132-GI | 79142-GI |
| | Weight in Pounds | 77 | 88 | 98 | 111 |
| | Price | | | | |
| 141 3/4" length | Item Number | 79114-GI | 79124-GI | 79134-GI | 79144-GI |
| | Weight in Pounds | 92.4 | 105.6 | 117.6 | 132 |
| | Price | | | | |

Panels, Non-Conventional Sizes, per foot

| | Nominal Height | 5' | 6' | 7' | 8' |
|------------------------------|------------------|----------|----------|----------|----------|
| 4" picket spacing | Item Number | 79210-GI | 79220-GI | 79230-GI | 79240-GI |
| | Weight in Pounds | 9 | 11 | 12 | 14 |
| | Price | | | | |
| 5 1/4" picket spacing | Item Number | 79212-GI | 79222-GI | 79232-GI | 79242-GI |
| | Weight in Pounds | 7.7 | 8.8 | 9.9 | 11 |
| | Price | | | | |

HEAVY REGAL, Galva-Guard I, Single Gate

Item # 79400-GI

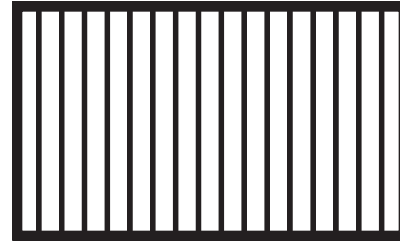
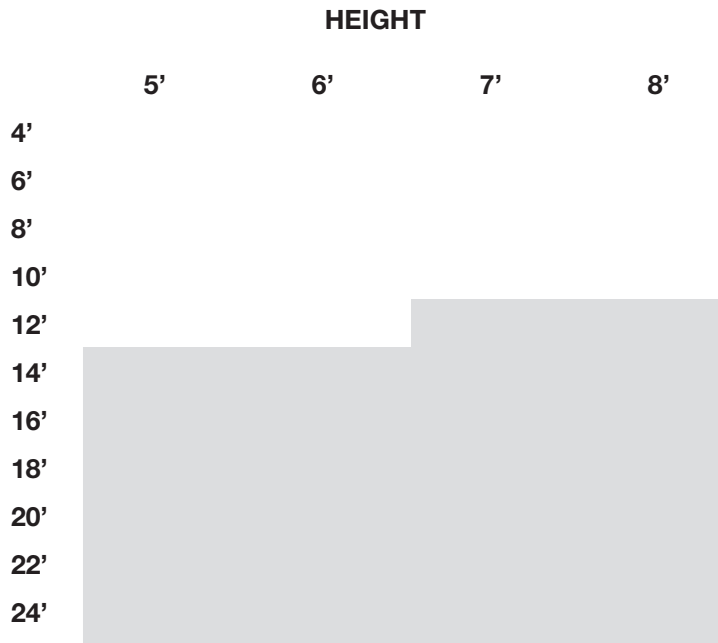

HEAVY REGAL, Galva-Guard I, Double Gate

Item # 79450-GI

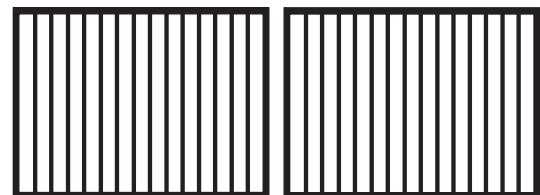
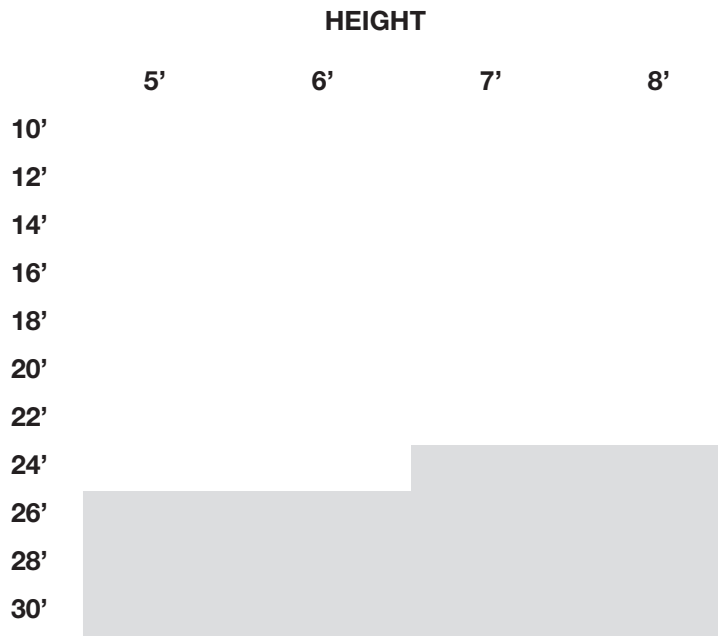

NOTES

Prices listed on this page are based on 4-inch picket spacing only and do not include hardware or trussing. Shaded areas on the pricing schedule indicate gates manufactured with a 2" frame required for additional strength.

FOR CUSTOM OPTIONS: arching, scroll work or a wide variety of design alternatives, see the **SPECIAL PRICING APPLICATIONS** section of this catalog.

Please call for special pricing.

CONVENTIONAL SLIDE GATE

GATE PRICES INCLUDE:

- 1 5/8" BFC 20 track
- 2 - P.S. pipe track wheels
- 2 - Clamp-on brackets
- 2 - P.S. caps
- 1 - 6" Rubber wheel
- Required track brackets
- Slide gate latch

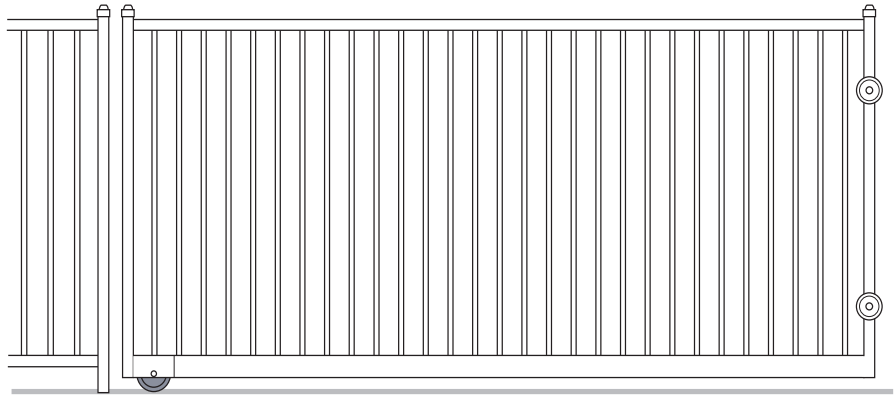

Item # 79474-GI

2" x 4" BOTTOM RAIL

Gates are manufactured with 2" top rail and sides with a 2" x 4" bottom rail (4" view), 3/4" sq. pickets and 4" picket spacing. Old style gates with square bottom rail and old style wheel boxes are available upon request.

Note: Ground clearance reduced to 2". Call for pricing on custom variations.

Note: UL 325 requires electronically operated gates and the fence line adjoining such gates to have a maximum 2 1/8" picket spacing or mesh installed. For additional cost, contact sales person.

HEAVY REGAL, Galva-Guard I, Conventional Slide Gate

HEIGHT

| | 3' | 4' | 5' | 6' |
|---|-----|----|----|----|
| O | 8' | | | |
| P | 10' | | | |
| E | 12' | | | |
| N | 14' | | | |
| I | 16' | | | |
| N | 18' | | | |
| G | 20' | | | |

FOR CUSTOM OPTIONS: arching, scroll work or a wide variety of design alternatives, see the **SPECIAL PRICING APPLICATIONS** section of this catalog.

Please call for special pricing.

BFC Ornamental Iron LIGHT ARISTOCRAT Galva-Guard I

PICKET POSITION

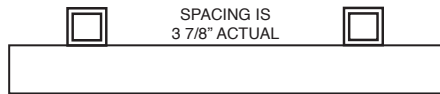

- 1" Square Top & Bottom Rail, 16 ga.
- 5/8" Square Pickets, 18 ga.
- 4" (3 7/8" actual) Spacing Between Pickets
- Tubing Galvanized before Fabrication
- Power Washed for Paint Preparation
- One Spray Coat High Solids Primer
- One Spray Coat Polyurethane Black
- Custom Colors Available at Additional Cost
- Choose from 14 Standard Colors — add 5%

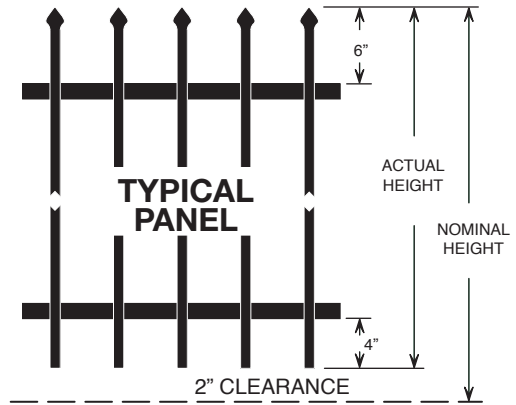

LIGHT ARISTOCRAT, Galva-Guard I, Conventional sizes

PRE-GALVANIZED TUBING & POLYURETHANE PAINTED

Panels

| | Nominal Height Actual Height | 3' 34" | 4' 46" | 5' 58" | 6' 70" |
|-----------------|---------------------------------|-----------|-----------|-----------|-----------|
| 94" length | Item Number | 69010-GI | 69110-GI | 69210-GI | 69310-GI |
| | Weight in Pounds | 36 | 44 | 52 | 60 |
| 120" length | Item Number | 69020-GI | 69120-GI | 69220-GI | 69320-GI |
| | Weight in Pounds | 46 | 56 | 66 | 76 |
| 143 1/2" length | Item Number | 69030-GI | 69130-GI | 69230-GI | 69330-GI |
| | Weight in Pounds | 54 | 66 | 78 | 90 |

Single Gates

Includes zinc plated standard hardware: an "A-Kit" and an "M-Kit"

| | Nominal Height Actual Height | 3' 34" | 4' 46" | 5' 58" | 6' 70" |
|------------|---------------------------------|-----------|-----------|-----------|-----------|
| 3' opening | Item Number | 69409-GI | 69419-GI | 69429-GI | 69439-GI |
| | Weight in Pounds | 17 | 21 | 25 | 30 |
| 4' opening | Item Number | 69410-GI | 69420-GI | 69430-GI | 69440-GI |
| | Weight in Pounds | 20 | 25 | 30 | 35 |

Double Gates

Includes zinc plated standard hardware: 2 "A-Kits" and an "R5-Kit"

| | Nominal Height Actual Height | 3' 34" | 4' 46" | 5' 58" | 6' 70" |
|-------------|---------------------------------|-----------|-----------|-----------|-----------|
| 10' opening | Item Number | 69449-GI | 69459-GI | 69469-GI | 69479-GI |
| | Weight in Pounds | 53 | 66 | 79 | 92 |
| 12' opening | Item Number | 69450-GI | 69460-GI | 69470-GI | 69480-GI |
| | Weight in Pounds | 60 | 74 | 88 | 102 |

BFC Ornamental Iron LIGHT ARISTOCRAT Galva-Guard I

LIGHT ARISTOCRAT, Galva-Guard I, Non-Conventional Sizes

PANELS • Item # 69000-GI

To determine prices for non-standard sizes, use this list of "per foot" prices.

| | | HEIGHT | | | | | | |
|----------|-----|--------|----|----|----|----|----|----|
| | | 2' | 3' | 4' | 5' | 6' | 7' | 8' |
| per foot | -XX | | | | | | | |

SINGLE GATES • Item # 69400-GI

Single Gates include zinc plated standard hardware: an "A-kit" and an "M-kit".

| | | HEIGHT | | | | | | |
|-------|-----|--------|----|----|----|----|----|----|
| | | 2' | 3' | 4' | 5' | 6' | 7' | 8' |
| WIDTH | 3' | | | | | | | |
| | 4' | | | | | | | |
| | 5' | | | | | | | |
| | 6' | | | | | | | |
| | 7' | | | | | | | |
| | 8' | | | | | | | |
| | 9' | | | | | | | |
| | 10' | | | | | | | |

DOUBLE GATES • Item # 69455-GI

Double Gates include zinc plated standard hardware: 2 "A-kits" and an "R5-kit".

| | | HEIGHT | | | | | | |
|-------|-----|--------|----|----|----|----|----|----|
| | | 2' | 3' | 4' | 5' | 6' | 7' | 8' |
| WIDTH | 6' | | | | | | | |
| | 8' | | | | | | | |
| | 10' | | | | | | | |
| | 12' | | | | | | | |
| | 14' | | | | | | | |
| | 16' | | | | | | | |
| | 18' | | | | | | | |
| | 20' | | | | | | | |

Prices are for rectangular fence and gates only.
 For BIAS fence and gates, add \$ per lineal foot.
 For TAPERED fence and gates, add \$ per lineal foot.

FOR CUSTOM OPTIONS: arching, scroll work or a wide variety of design alternatives, see the **SPECIAL PRICING APPLICATIONS** section of this catalog.

BFC Ornamental Iron HEAVY ARISTOCRAT Galva-Guard I

PICKET POSITION

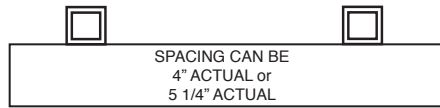

- 1 1/2" Square Top & Bottom Rail, 14 ga.
- 3/4" Square Pickets, 16 ga.
- 4" or 5 1/4" Spacing between Pickets
- Tubing Galvanized before Fabrication
- Power Washed for Paint Preparation
- One Spray Coat High Solids Primer
- One Spray Coat Polyurethane Black
- Custom Colors Available at Additional Cost
- Choose from 14 Standard Colors — add 5%

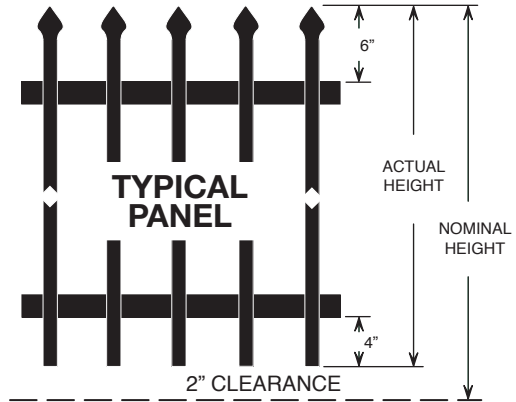

HEAVY ARISTOCRAT, Galva-Guard I, Conventional sizes PRE-GALVANIZED TUBING & POLYURETHANE PAINTED

Panels, Conventional Sizes, 4" PICKET SPACING

| | Nominal Height | 5' | 6' | 7' | 8' |
|------------------------|------------------|----------|----------|----------|----------|
| 94" length | Item Number | 80010-GI | 80020-GI | 80030-GI | 80040-GI |
| | Weight in Pounds | 78.4 | 90.4 | 101.6 | 113.6 |
| | Price | | | | |
| 118" length | Item Number | 80012-GI | 80022-GI | 80032-GI | 80042-GI |
| | Weight in Pounds | 98.0 | 113.0 | 127.0 | 142.0 |
| | Price | | | | |
| 141 3/4" length | Item Number | 80014-GI | 80024-GI | 80034-GI | 80044-GI |
| | Weight in Pounds | 117.6 | 135.6 | 152.4 | 170.4 |
| | Price | | | | |

Panels, Conventional Sizes, 5 1/4" PICKET SPACING

| | Nominal Height | 5' | 6' | 7' | 8' |
|------------------------|------------------|----------|----------|----------|----------|
| 94" length | Item Number | 80110-GI | 80120-GI | 80130-GI | 80140-GI |
| | Weight in Pounds | 64.8 | 73.6 | 82.4 | 91.2 |
| | Price | | | | |
| 118" length | Item Number | 80112-GI | 80122-GI | 80132-GI | 80142-GI |
| | Weight in Pounds | 81.0 | 92.0 | 103.0 | 114.0 |
| | Price | | | | |
| 141 3/4" length | Item Number | 80114-GI | 80124-GI | 80134-GI | 80144-GI |
| | Weight in Pounds | 97.2 | 110.4 | 123.6 | 136.8 |
| | Price | | | | |

Panels, Non-Conventional Sizes, per foot

| | Nominal Height | 5' | 6' | 7' | 8' |
|------------------------------|------------------|----------|----------|----------|----------|
| 4" picket spacing | Item Number | 80210-GI | 80220-GI | 80230-GI | 80240-GI |
| | Weight in Pounds | 9.8 | 11.3 | 12.7 | 14.2 |
| | Price | | | | |
| 5 1/4" picket spacing | Item Number | 80212-GI | 80222-GI | 80232-GI | 80242-GI |
| | Weight in Pounds | 8.1 | 9.2 | 10.3 | 11.4 |
| | Price | | | | |

BFC Ornamental Iron HEAVY ARISTOCRAT Galva-Guard I

HEAVY ARISTOCRAT, Galva-Guard I, Single Gate

Item # 80400-GI

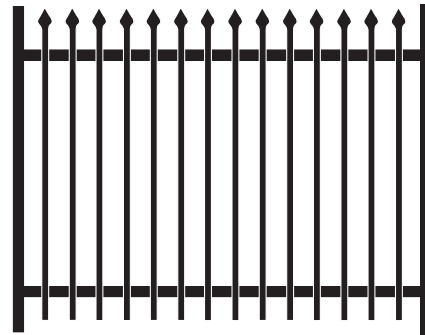
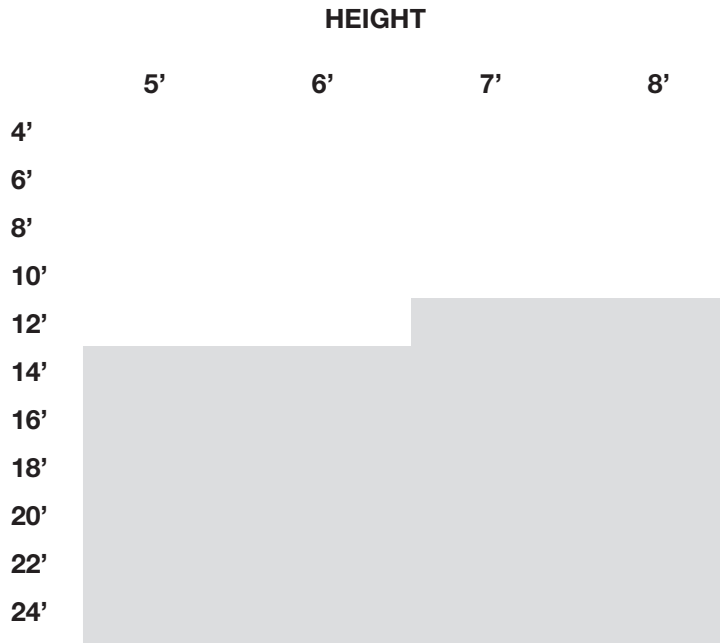

HEAVY ARISTOCRAT, Galva-Guard I, Double Gate

Item # 80450-GI

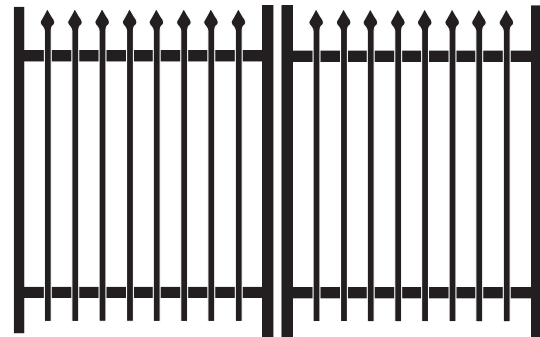
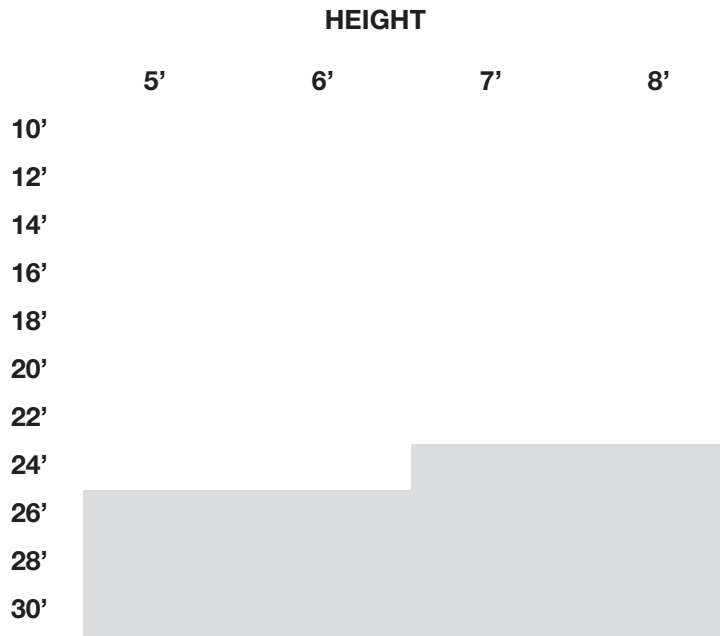

NOTES

Prices listed on this page are based on 4-inch picket spacing only and do not include hardware or trussing. Shaded areas on the pricing schedule indicate gates manufactured with a 2" frame required for additional strength.

FOR CUSTOM OPTIONS: arching, scroll work or a wide variety of design alternatives, see the **SPECIAL PRICING APPLICATIONS** section of this catalog.

Please call for special pricing.

CONVENTIONAL SLIDE GATE

GATE PRICES INCLUDE:

- 1 5/8" BFC 20 track
- 2 - P.S. pipe track wheels
- 2 - Clamp-on brackets
- 2 - P.S. caps
- 1 - 6" Rubber wheel
- Required track brackets
- Slide gate latch

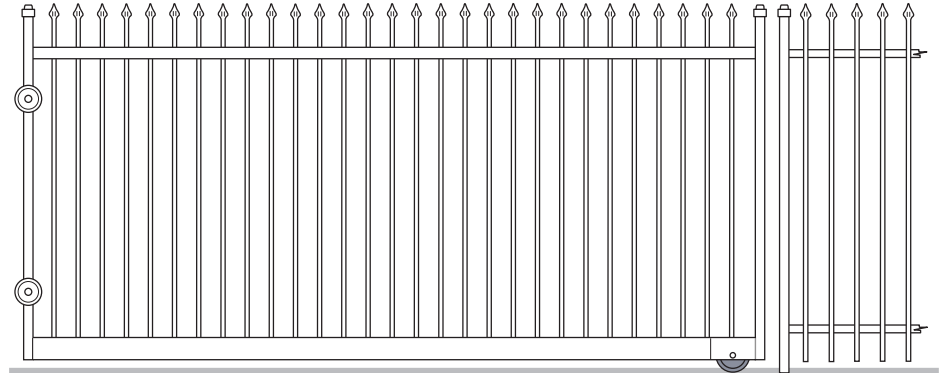

Item # 80474-GI

2" x 4" BOTTOM RAIL

Gates are manufactured with 2" top rail and sides with a 2" x 4" bottom rail (4" view), 3/4" sq. pickets and 4" picket spacing. Old style gates with square bottom rail, old style wheel boxes, and pickets on the outside of the rail are available on request.

Call for pricing on custom variations.

End View Detail



- Split Pickets
- Straighter gates because there is no welding on the outside of rails
- Wheel box part of bottom rail

Note: UL 325 requires electronically operated gates and the fence line adjoining such gates to have a maximum 2 1/8" picket spacing or mesh installed. For additional cost, contact sales person.

HEAVY ARISTOCRAT, Galva-Guard I, Conventional Slide Gate

HEIGHT

| | 3' | 4' | 5' | 6' |
|---|-----|----|----|----|
| O | 8' | | | |
| P | 10' | | | |
| E | 12' | | | |
| N | 14' | | | |
| I | 16' | | | |
| N | 18' | | | |
| G | 20' | | | |

FOR CUSTOM OPTIONS: arching, scroll work or a wide variety of design alternatives, see the **SPECIAL PRICING APPLICATIONS** section of this catalog.

Please call for special pricing.

BFC Ornamental Iron HEAVY ARISTOCRAT Galva-Guard I

OVERHEAD ROLLER STYLE

End View Detail

GATE PRICES INCLUDE:

- 2 - P.S. caps
- 1 - Roller assembly
- 1 - Industrial slide latch
- 2 - 6" V-Groove wheels
- Galvanized V-Track with J-bolts or tabs

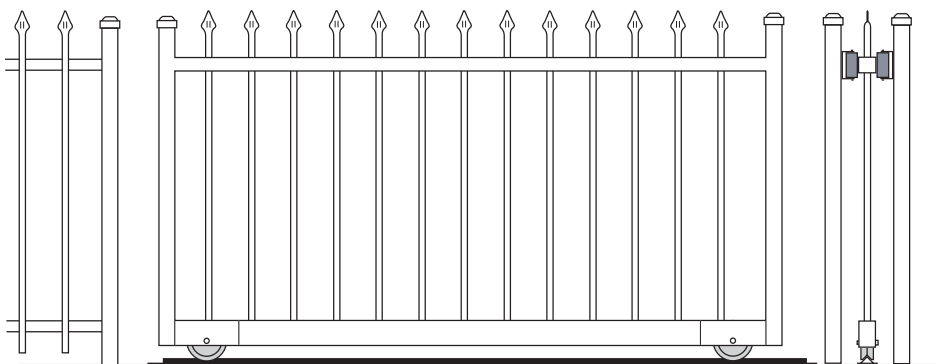

End View Detail

- Split Pickets

Item # 80475-GI

2" x 4" BOTTOM RAIL



- Straighter gates because there is no welding on the outside of rails
- No strap needed across the pickets
- Wheel box part of bottom rail

Gates are manufactured with 2" top rail and sides with a 2" x 4" bottom rail (4" view), 3/4" sq. pickets and 4" picket spacing. Old style gates with square bottom rail, old style wheel boxes, and pickets on the outside of the rail are available on request. Call for pricing on custom variations. Shaded areas on the pricing schedule indicate gates manufactured with an 11 gauge frame required for additional strength. Trussing is optional and may be required for larger gates sizes. Refer to SPECIAL PRICING APPLICATION section.

Note: UL 325 requires electronically operated gates and the fence line adjoining such gates to have a maximum 2 1/8" picket spacing or mesh installed. For additional cost, contact sales person.

HEAVY ARISTOCRAT, Galva-Guard I, Overhead Roller Assembly Style Slide Gate

| | | HEIGHT | | | | | |
|---|-----|--------|----|----|----|----|----|
| | | 3' | 4' | 5' | 6' | 7' | 8' |
| | 10' | | | | | | |
| O | 12' | | | | | | |
| P | 14' | | | | | | |
| E | 16' | | | | | | |
| N | 18' | | | | | | |
| I | 20' | | | | | | |
| N | 22' | | | | | | |
| G | 24' | | | | | | |
| | 26' | | | | | | |
| | 28' | | | | | | |
| | 30' | | | | | | |

FOR CUSTOM OPTIONS: arching, scroll work or a wide variety of design alternatives, see the **SPECIAL PRICING APPLICATIONS** section of this catalog.

Please call for special pricing.

BFC Ornamental Iron

HEAVY GUARDIAN
Galva-Guard I

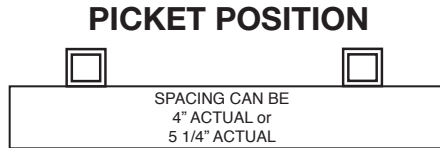

- 1 1/2" Square Top & Bottom Rail, 14 ga.
- 3/4" Square Pickets, 16 ga.
- 4" or 5 1/4" Spacing between Pickets
- Tubing Galvanized before Fabrication
- Power Washed for Paint Preparation
- One Spray Coat High Solids Primer
- One Spray Coat Polyurethane Black
- Custom Colors Available at Additional Cost
- Choose from 14 Standard Colors — add 5%

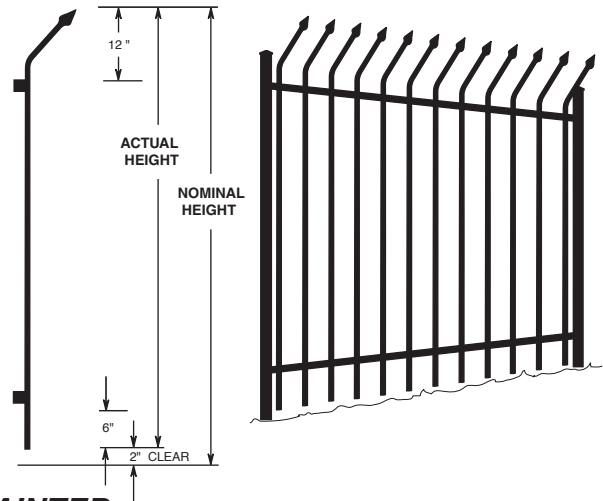

HEAVY GUARDIAN, Galva-Guard I PRE-GALVANIZED TUBING & POLYURETHANE PAINTED

Panels, Conventional Sizes, 4" PICKET SPACING

| Nominal Height | 7' | 8' | 9' | 10' |
|-----------------|---|---|---|---|
| 94" length | Item Number: 81010-GI Weight in Pounds: 105.6 Price | Item Number: 81020-GI Weight in Pounds: 117.6 Price | Item Number: 81030-GI Weight in Pounds: 128.8 Price | Item Number: 81040-GI Weight in Pounds: 140.8 Price |
| 118" length | Item Number: 81012-GI Weight in Pounds: 132.0 Price | Item Number: 81022-GI Weight in Pounds: 147.0 Price | Item Number: 81032-GI Weight in Pounds: 161.0 Price | Item Number: 81042-GI Weight in Pounds: 176.0 Price |
| 141 3/4" length | Item Number: 81014-GI Weight in Pounds: 158.4 Price | Item Number: 81024-GI Weight in Pounds: 176.4 Price | Item Number: 81034-GI Weight in Pounds: 193.2 Price | Item Number: 81044-GI Weight in Pounds: 211.2 Price |

Panels, Conventional Sizes, 5 1/4" PICKET SPACING

| Nominal Height | 7' | 8' | 9' | 10' |
|-----------------|---|---|---|---|
| 94" length | Item Number: 81110-GI Weight in Pounds: 88.8 Price | Item Number: 81120-GI Weight in Pounds: 98.4 Price | Item Number: 81130-GI Weight in Pounds: 108.0 Price | Item Number: 81140-GI Weight in Pounds: 116.8 Price |
| 118" length | Item Number: 81112-GI Weight in Pounds: 111.0 Price | Item Number: 81122-GI Weight in Pounds: 123.0 Price | Item Number: 81132-GI Weight in Pounds: 135.0 Price | Item Number: 81142-GI Weight in Pounds: 146.0 Price |
| 141 3/4" length | Item Number: 81114-GI Weight in Pounds: 133.2 Price | Item Number: 81124-GI Weight in Pounds: 147.6 Price | Item Number: 81134-GI Weight in Pounds: 162.0 Price | Item Number: 81144-GI Weight in Pounds: 175.2 Price |

Panels, Non-Conventional Sizes, per foot

| Nominal Height | 7' | 8' | 9' | 10' |
|-----------------------|--|--|--|--|
| 4" picket spacing | Item Number: 81210-GI Weight in Pounds: 13.2 Price | Item Number: 81220-GI Weight in Pounds: 14.7 Price | Item Number: 81230-GI Weight in Pounds: 16.1 Price | Item Number: 81240-GI Weight in Pounds: 17.6 Price |
| 5 1/4" picket spacing | Item Number: 81212-GI Weight in Pounds: 11.1 Price | Item Number: 81222-GI Weight in Pounds: 12.3 Price | Item Number: 81232-GI Weight in Pounds: 13.5 Price | Item Number: 81242-GI Weight in Pounds: 14.6 Price |

The shaded items are too large to be Factory painted, they are furnished not cleaned of mill oil and not painted.

HEAVY GUARDIAN, Galva-Guard I, Single Gate

Item # 81400-GI

| | | HEIGHT | | | |
|-----|--|--------|----|----|-------|
| | | 7' | 8' | 9' | * 10' |
| 4' | | | | | |
| 6' | | | | | |
| 8' | | | | | |
| 10' | | | | | * |
| 12' | | | | | * |
| 14' | | | | | * |
| 16' | | | | | * |
| 18' | | | | | * |
| 20' | | | | | * |
| 22' | | | | | * |
| 24' | | | | | * |

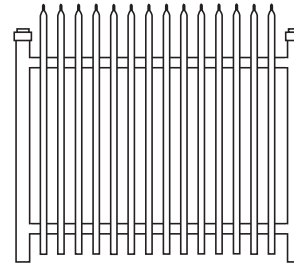

HEAVY GUARDIAN, Galva-Guard I, Double Gate

Item # 81450-GI

| | | HEIGHT | | | |
|-----|--|--------|----|----|-------|
| | | 7' | 8' | 9' | * 10' |
| 10' | | | | | |
| 12' | | | | | |
| 14' | | | | | |
| 16' | | | | | |
| 18' | | | | | |
| 20' | | | | | * |
| 22' | | | | | * |
| 24' | | | | | * |
| 26' | | | | | * |
| 28' | | | | | * |
| 30' | | | | | * |

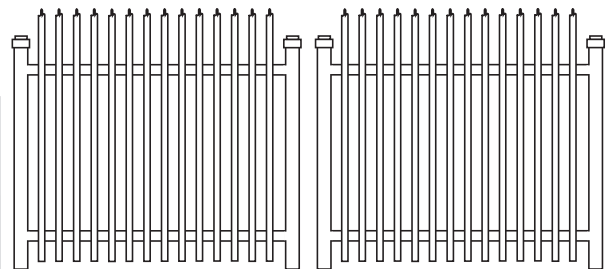

NOTES

Prices listed on this page are based on 4-inch picket spacing only and do not include hardware or trussing. Shaded areas on the pricing schedule indicate gates manufactured with a 2" frame required for additional strength.

FOR CUSTOM OPTIONS: arching, scroll work or a wide variety of design alternatives, see the **SPECIAL PRICING APPLICATIONS** section of this catalog.

* All 10' Guardian swing gates over 9' in width are too large to be factory painted. They are furnished not cleaned of mill oil and not painted.

CONVENTIONAL SLIDE GATE

GATE PRICES INCLUDE:

- 1 5/8" BFC 20 track
- 2 - P.S. pipe track wheels
- 2 - Clamp-on brackets
- 2 - P.S. caps
- 1 - 6" Rubber wheel
- Required track brackets
- Slide gate latch

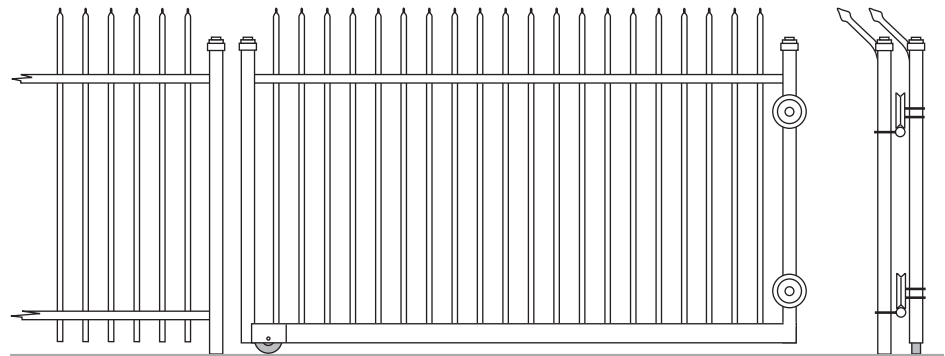

Item # 81474-GI

2" x 4" BOTTOM RAIL

Gates are manufactured with 2" top rail and sides with a 2" x 4" bottom rail (4" view), 3/4" sq. pickets and 4" picket spacing. Old style gates with square bottom rail, old style wheel boxes, and pickets on the outside of the rail are available on request.

Call for pricing on custom variations.

End View Detail

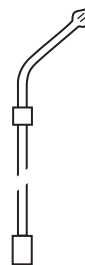

- Split Pickets
- Straighter gates because there is no welding on the outside of rails
- Wheel box part of bottom rail

Note: UL 325 requires electronically operated gates and the fence line adjoining such gates to have a maximum 2 1/8" picket spacing or mesh installed. For additional cost, contact sales person.

HEAVY GUARDIAN, Galva-Guard I, Conventional Slide Gate

| | | HEIGHT | | |
|---|-----|--------|----|----|
| O | | 7' | 8' | 9' |
| P | | | | |
| E | 10' | | | |
| N | 12' | | | |
| I | 14' | | | |
| N | 16' | | | |
| G | | | | |

FOR CUSTOM OPTIONS: arching, scroll work or a wide variety of design alternatives, see the **SPECIAL PRICING APPLICATIONS** section of this catalog.

Please call for special pricing.

OVERHEAD ROLLER STYLE

GATE PRICES INCLUDE:

- 2 - P.S. caps
- 1 - Roller assembly
- 1 - Industrial slide latch
- 2 - 6" V-Groove wheels
- Galvanized V-Track with J-bolts or tabs

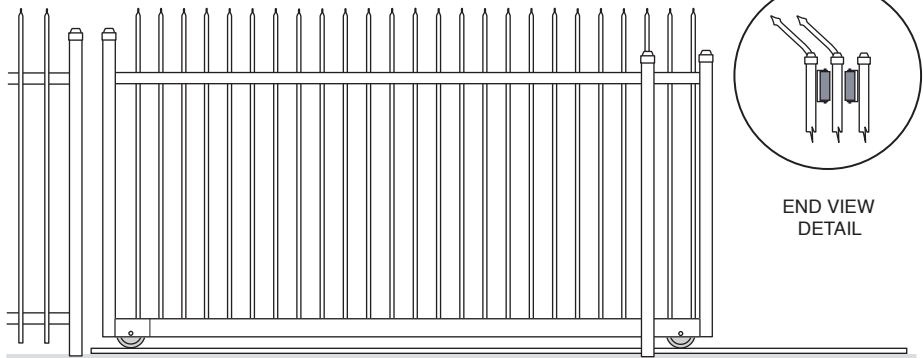

End View Detail

- Split Pickets
- Straighter gates because there is no welding on the outside of rails
- No strap needed across the pickets
- Wheel box part of bottom rail

Item # 81475-GI

2" x 4" BOTTOM RAIL

Gates are manufactured with 2" top rail and sides with a 2" x 4" bottom rail (4" view), 3/4" sq. pickets and 4" picket spacing. Old style gates with square bottom rail, old style wheel boxes, and pickets on the outside of the rail are available on request. Call for pricing on custom variations. Shaded areas on the pricing schedule indicate gates manufactured with an 11 gauge frame required for additional strength. Trussing is optional and may be required for larger gates sizes. Refer to SPECIAL PRICING APPLICATION section.

Note: UL 325 requires electronically operated gates and the fence line adjoining such gates to have a maximum 2 1/8" picket spacing or mesh installed. For additional cost, contact sales person.

HEAVY GUARDIAN, Galva-Guard I, Overhead Roller Assembly Style Slide Gate

| | | HEIGHT | | | |
|---|-----|--------|----|----|-------|
| | | 7' | 8' | 9' | * 10' |
| | 10' | | | | * |
| O | 12' | | | | * |
| P | 14' | | | | * |
| E | 16' | | | | * |
| N | 18' | | | | * |
| I | 20' | | | | * |
| N | 22' | | | | * |
| G | 24' | | | | * |
| | 26' | | | | * |
| | 28' | | | | * |
| | 30' | | | | * |

* All 10' Guardian slide gates over 9' in width are too large to be factory painted. They are furnished not cleaned of mill oil and not painted.

FOR CUSTOM OPTIONS: arching, scroll work or a wide variety of design alternatives, see the **SPECIAL PRICING APPLICATIONS** section of this catalog.

BFC Ornamental Iron

LIGHT REGAL
Powder Coat

PANELS

PICKET POSITION

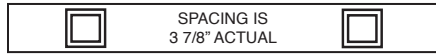

- 1" Square Top & Bottom Rail, 16 ga.
- 5/8" Square Pickets, 18 ga.
- 4" (3 7/8" actual) Spacing between Pickets
- Powder Coat Black

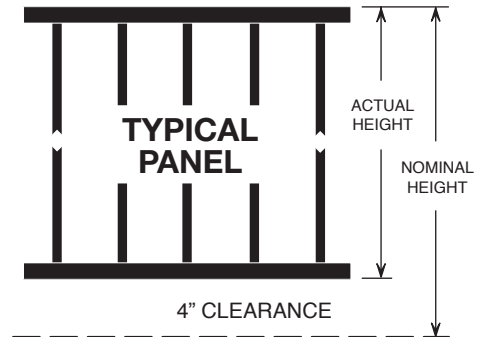

LIGHT REGAL, POWDER COAT For Pre-Galvanized add 35%

Panels

| | Nominal Height Actual Height | 3' 32" | 3 1/2' 38" | 4' 44" | SPECIAL 58" | 6' 68" |
|-------------|---------------------------------|-----------|---------------|-----------|----------------|-----------|
| 94" length | Item Number | 68010-PC | 68040-PC | 68110-PC | 68240-PC | 68310-PC |
| | Weight in Pounds | 33 | 37 | 41 | 51 | 57 |
| | Price | | | | | |
| 120" length | Item Number | 68020-PC | 68050-PC | 68120-PC | 68250-PC | 68320-PC |
| | Weight in Pounds | 42 | 47 | 52 | 64 | 72 |
| | Price | | | | | |

PANELS

PICKET POSITION

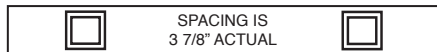

- 1" Square Top & Bottom Rail, 16 ga.
- 5/8" Square Pickets, 18 ga.
- 4" (3 7/8" actual) Spacing between Pickets
- Powder Coat Black

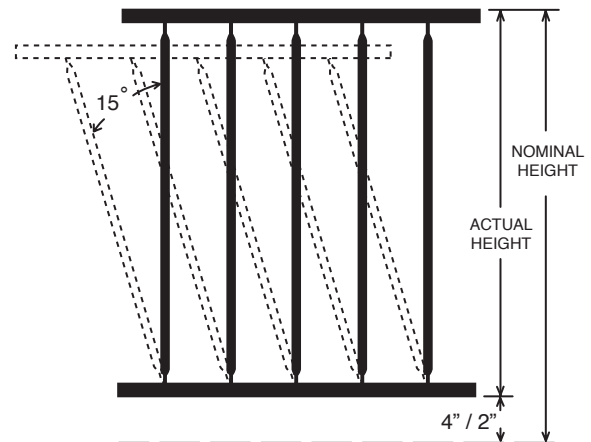

LIGHT REGAL, POWDER COAT BIASABLE

Panels

| | Nominal Height Actual Height | 3' 32" | 3 1/2' 38" | 4' 44" | SPECIAL 58" | 6' 68" |
|-------------|---------------------------------|-----------|---------------|-----------|----------------|-----------|
| 94" length | Item Number | 77010-PC | 77041-PC | 77110-PC | 77240-PC | 77310-PC |
| | Weight in Pounds | 33 | 37 | 41 | 51 | 57 |
| | Price | | | | | |
| 120" length | Item Number | 77020-PC | 77042-PC | 77120-PC | 77250-PC | 77320-PC |
| | Weight in Pounds | 42 | 47 | 52 | 64 | 72 |
| | Price | | | | | |

BFC Ornamental Iron LIGHT ARISTOCRAT Powder Coat

PANELS

PICKET POSITION

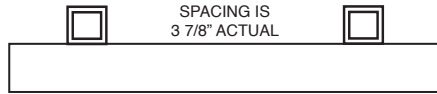

- 1" Square Top & Bottom Rail, 16 ga.
- 5/8" Square Pickets, 18 ga.
- 4 1/2" O.C. (3 7/8" actual) Spacing Between Pickets
- Powder Coat Black

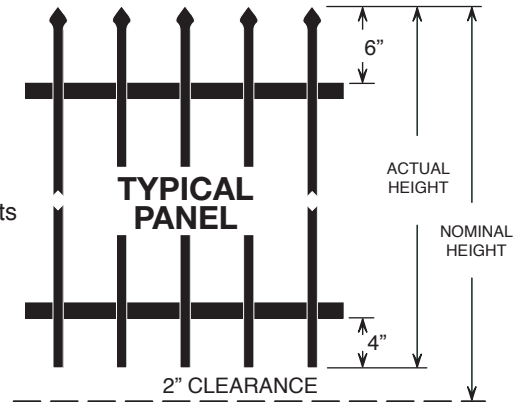

LIGHT ARISTOCRAT, POWDER COAT
 Biasable available at no extra charge
 For Pre-Galvanized add 35%

Panels

| | Nominal Height Actual Height | 3' 34" | 4' 46" | 5' 58" | 6' 70" |
|-------------|---------------------------------|-----------|-----------|-----------|-----------|
| 94" length | Item Number | 69010-PC | 69110-PC | 69210-PC | 69310-PC |
| | Weight in Pounds | 36 | 44 | 52 | 60 |
| 120" length | Item Number | 69020-PC | 69120-PC | 69220-PC | 69320-PC |
| | Weight in Pounds | 46 | 56 | 66 | 76 |

POWDER COATED

POST PRICES

PRESSED STEEL CAP INCLUDED

2" SQ POSTS

14 GA

| Post Length | Item# | Size | Price |
|-------------|-------------|---------|-------|
| 6' | 82300PC-072 | 2" x 6' | |
| 7' | 82300PC-084 | 2" x 7' | |
| 8' | 82300PC-096 | 2" x 8' | |
| 9' | 82300PC-108 | 2" x 9' | |

LBS/FT **1.87**

3" SQ POSTS

11 GA

| Post Length | Item# | Size | Price |
|-------------|-------------|---------|-------|
| 8' | 82550PC-096 | 3" x 8' | |
| 9' | 82550PC-108 | 3" x 9' | |

LBS/FT **4.57**

GATE SIDES

2 1/2" SQ POSTS

11 GA

| Post Length | Item# | Size | Price |
|-------------|-------------|-------------|-------|
| 8' | 82500PC-096 | 2 1/2" x 8' | |
| 9' | 82500PC-108 | 2 1/2" x 9' | |

LBS/FT **3.76**

1" GATE SIDES

16 GA

| Height | Item# | Size | Price |
|---------|-------------|---------------|-------|
| 58 3/4" | 82950PC-058 | 5' x 1" 16 GA | |
| 68 3/4" | 82950PC-068 | 6' x 1" 16 GA | |

LBS/FT **.767**

PICKET POSITION

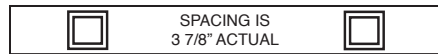

- 1" Square Top & Bottom Rail, 16 ga.
- 5/8" Square Pickets, 18 ga.
- 4" (3 7/8" actual) Spacing between Pickets
- Power Washed for Paint Preparation
- One Shop Prime Coat
- One Top Coat Black Enamel

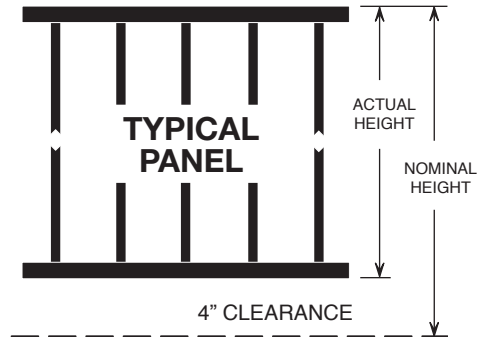

LIGHT REGAL, Two Coat, Conventional Sizes

For black polyurethane top coat add 10% to these prices
For pre-galvanized rail & pickets add 45% to these prices

Panels

| | Nominal Height Actual Height | 3' 32" | 3 1/2' 38" | 4' 44" | 5' 56" | SPECIAL 58" | 6' 68" |
|------------------------|---------------------------------|-----------|---------------|-----------|-----------|----------------|-----------|
| 94" length | Item Number | 68010-D | 68040-D | 68110-D | 68210-D | 68240-D | 68310-D |
| | Weight in Pounds | 33 | 37 | 41 | 49 | 51 | 57 |
| 120" length | Item Number | 68020-D | 68050-D | 68120-D | 68220-D | 68250-D | 68320-D |
| | Weight in Pounds | 42 | 47 | 52 | 62 | 64 | 72 |
| 143 1/2" length | Item Number | 68030-D | 68060-D | 68130-D | 68230-D | 68260-D | 68330-D |
| | Weight in Pounds | 50 | 56 | 62 | 74 | 77 | 86 |

Single Gates

Includes standard hardware: an "A-Kit" and an "M-Kit"

| | Nominal Height Actual Height | 3' 32" | 3 1/2' 38" | 4' 44" | 5' 56" | SPECIAL 58" | 6' 68" |
|-------------------|---------------------------------|-----------|---------------|-----------|-----------|----------------|-----------|
| 3' opening | Item Number | 68409-D | 68414-D | 68419-D | 68429-D | 68435-D | 68439-D |
| | Weight in Pounds | 16 | 18 | 20 | 24 | 25 | 29 |
| 4' opening | Item Number | 68410-D | 68415-D | 68420-D | 68430-D | 68436-D | 68440-D |
| | Weight in Pounds | 19 | 22 | 24 | 29 | 31 | 34 |

Double Gates

Includes standard hardware: 2 "A-Kits" and an "R5-Kit"

| | Nominal Height Actual Height | 3' 32" | 3 1/2' 38" | 4' 44" | 5' 56" | SPECIAL 58" | 6' 68" |
|--------------------|---------------------------------|-----------|---------------|-----------|-----------|----------------|-----------|
| 10' opening | Item Number | 68449-D | 68454-D | 68459-D | 68469-D | 68485-D | 68479-D |
| | Weight in Pounds | 49 | 56 | 62 | 75 | 78 | 88 |
| 12' opening | Item Number | 68450-D | 68455-D | 68460-D | 68470-D | 68487-D | 68480-D |
| | Weight in Pounds | 56 | 63 | 70 | 84 | 87 | 98 |

BFC Ornamental Iron

LIGHT REGAL
Two Coat

LIGHT REGAL, Two Coat, Non-Conventional Sizes

PANELS • Item # 68000-D

To determine prices for non-standard sizes, use this list of "per foot" prices.

| | | HEIGHT | | | | | | | |
|----------|-----|--------|----|--------|----|----|----|----|----|
| | | 2' | 3' | 3 1/2' | 4' | 5' | 6' | 7' | 8' |
| per foot | -XX | | | | | | | | |

SINGLE GATES • Item # 68400-D

Single Gates include standard hardware: an "A-kit" and an "M-kit".

| | | HEIGHT | | | | | | | |
|-------|-----|--------|----|--------|----|----|----|----|----|
| | | 2' | 3' | 3 1/2' | 4' | 5' | 6' | 7' | 8' |
| WIDTH | 3' | | | | | | | | |
| | 4' | | | | | | | | |
| | 5' | | | | | | | | |
| | 6' | | | | | | | | |
| | 7' | | | | | | | | |
| | 8' | | | | | | | | |
| | 9' | | | | | | | | |
| | 10' | | | | | | | | |

DOUBLE GATES • Item # 68455-D

Double Gates include standard hardware: 2 "A-kits" and an "R5-kit".

| | | HEIGHT | | | | | | | |
|-------|-----|--------|----|--------|----|----|----|----|----|
| | | 2' | 3' | 3 1/2' | 4' | 5' | 6' | 7' | 8' |
| WIDTH | 6' | | | | | | | | |
| | 8' | | | | | | | | |
| | 10' | | | | | | | | |
| | 12' | | | | | | | | |
| | 14' | | | | | | | | |
| | 16' | | | | | | | | |
| | 18' | | | | | | | | |
| | 20' | | | | | | | | |

Prices are for rectangular fence and gates only.
For BIAS fence and gates, add \$ per lineal foot.
For TAPERED fence and gates, add \$ per lineal foot.

FOR CUSTOM OPTIONS: arching, scroll work or a wide variety of design alternatives, see the **SPECIAL PRICING APPLICATIONS** section of this catalog.

PICKET POSITION

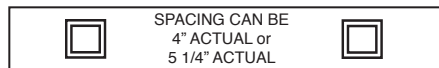

- 1 1/2" Square Top & Bottom Rail, 14 ga.
- 3/4" Square Pickets, 16 ga.
- 4" or 5 1/4" Spacing between Pickets
- Power Washed for Paint Preparation
- One Shop Prime Coat
- One Top Coat Black Enamel

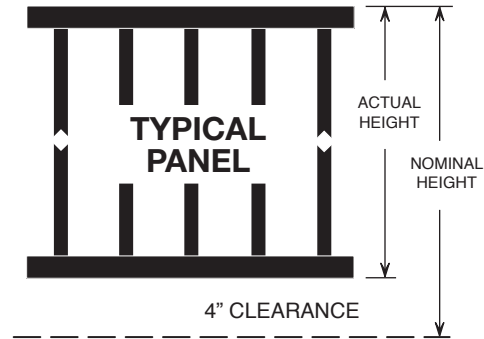

HEAVY REGAL, Two Coat

For black polyurethane top coat add 10% to these prices
For pre-galvanized rail & pickets add 35% to these prices

Panels, Conventional Sizes, 4" PICKET SPACING

| Nominal Height | 5' | 6' | 7' | 8' | |
|-----------------|------------------|---------|---------|---------|---------|
| 94" length | Item Number | 79010-D | 79020-D | 79030-D | 79040-D |
| | Weight in Pounds | 74.4 | 86.4 | 97.6 | 109.6 |
| | Price | | | | |
| 118" length | Item Number | 79012-D | 79022-D | 79032-D | 79042-D |
| | Weight in Pounds | 93 | 108 | 122 | 137 |
| | Price | | | | |
| 141 3/4" length | Item Number | 79014-D | 79024-D | 79034-D | 79044-D |
| | Weight in Pounds | 111.6 | 129.6 | 146.4 | 164.4 |
| | Price | | | | |

Panels, Conventional Sizes, 5 1/4" PICKET SPACING

| Nominal Height | 5' | 6' | 7' | 8' | |
|-----------------|------------------|---------|---------|---------|---------|
| 94" length | Item Number | 79110-D | 79120-D | 79130-D | 79140-D |
| | Weight in Pounds | 61.6 | 70.4 | 78.4 | 88 |
| | Price | | | | |
| 118" length | Item Number | 79112-D | 79122-D | 79132-D | 79142-D |
| | Weight in Pounds | 77 | 88 | 98 | 111 |
| | Price | | | | |
| 141 3/4" length | Item Number | 79114-D | 79124-D | 79134-D | 79144-D |
| | Weight in Pounds | 92.4 | 105.6 | 117.6 | 132 |
| | Price | | | | |

Panels, Non-Conventional Sizes, per foot

| Nominal Height | 5' | 6' | 7' | 8' | |
|-----------------------|------------------|---------|---------|---------|---------|
| 4" picket spacing | Item Number | 79210-D | 79220-D | 79230-D | 79240-D |
| | Weight in Pounds | 9.3 | 10.8 | 12.2 | 13.7 |
| | Price | | | | |
| 5 1/4" picket spacing | Item Number | 79212-D | 79222-D | 79232-D | 79242-D |
| | Weight in Pounds | 7.7 | 8.8 | 9.9 | 11 |
| | Price | | | | |

HEAVY REGAL, Two Coat, Single Gate

Item # 79400-D

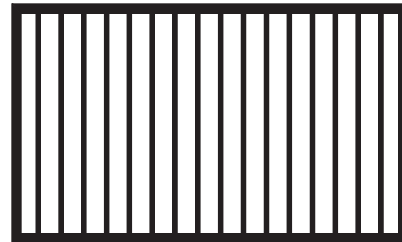
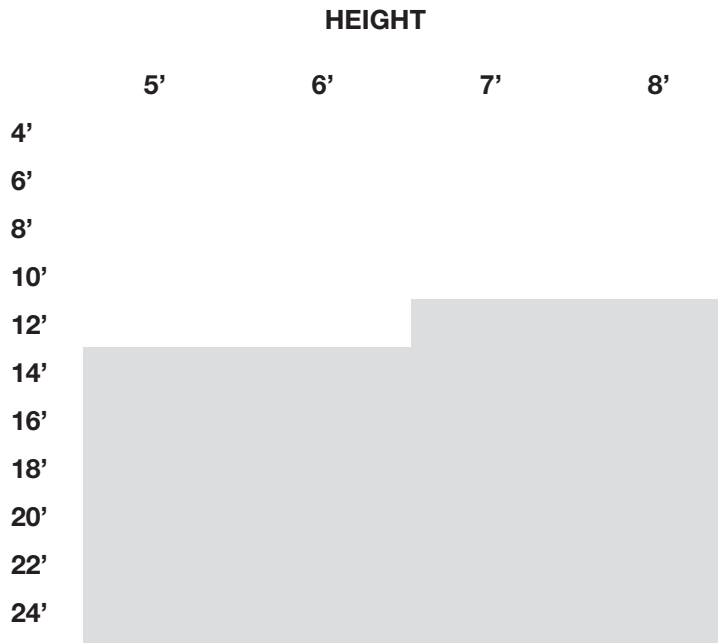

HEAVY REGAL, Two Coat, Double Gate

Item # 79450-D

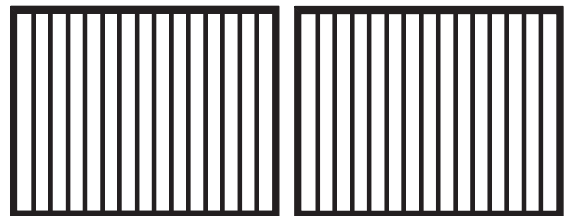
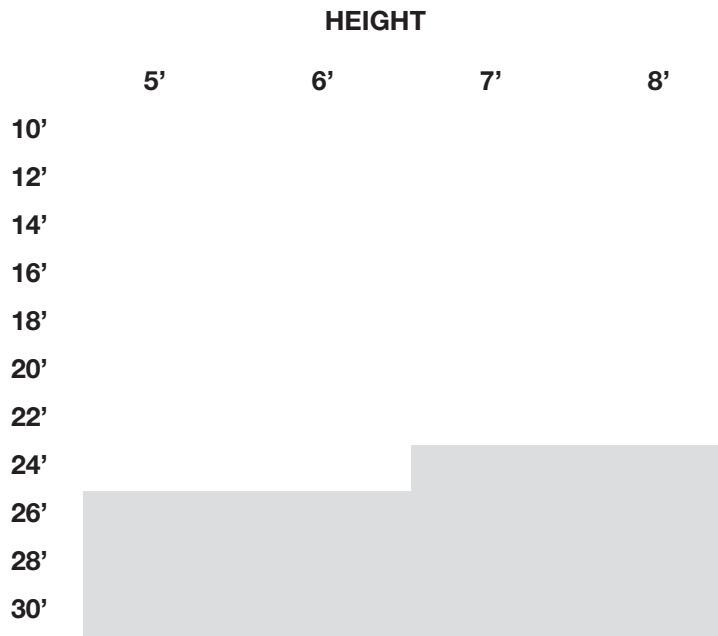

NOTES

Prices listed on this page are based on 4-inch picket spacing only and do not include hardware or trussing. Shaded areas on the pricing schedule indicate gates manufactured with a 2" frame required for additional strength.

FOR CUSTOM OPTIONS: arching, scroll work or a wide variety of design alternatives, see the **SPECIAL PRICING APPLICATIONS** section of this catalog.

Please call for special pricing.

CONVENTIONAL SLIDE GATE

GATE PRICES INCLUDE:

- 1 5/8" BFC 20 track
- 2 - P.S. pipe track wheels
- 2 - Clamp-on brackets
- 2 - P.S. caps
- 1 - 6" Rubber wheel
- Required track brackets
- Slide gate latch

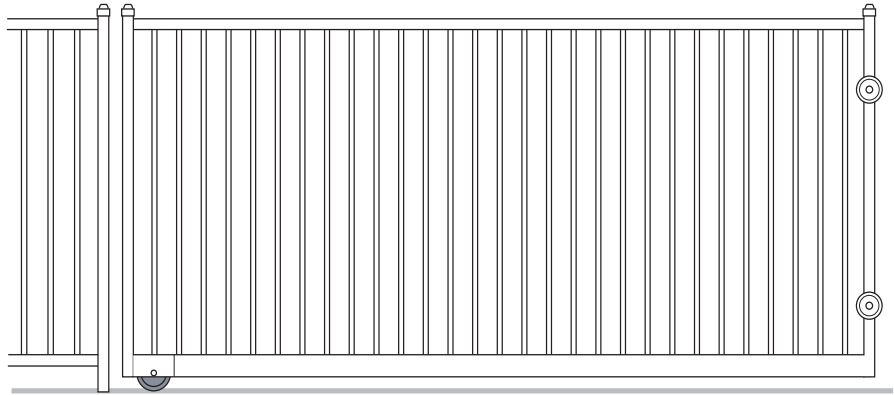

Item # 79474-D

2" x 4" BOTTOM RAIL

Gates are manufactured with 2" top rail and sides with a 2" x 4" bottom rail (4" view), 3/4" sq. pickets and 4" picket spacing. Old style gates with square bottom rail and old style wheel boxes are available upon request.

Note: Ground clearance reduced to 2". Call for pricing on custom variations.

Note: UL 325 requires electronically operated gates and the fence line adjoining such gates to have a maximum 2 1/8" picket spacing or mesh installed. For additional cost, contact sales person.

HEAVY REGAL, Two Coat, Conventional Slide Gate

HEIGHT

| | 3' | 4' | 5' | 6' |
|---|-----|----|----|----|
| O | 8' | | | |
| P | 10' | | | |
| E | 12' | | | |
| N | 14' | | | |
| I | 16' | | | |
| N | 18' | | | |
| G | 20' | | | |

FOR CUSTOM OPTIONS: arching, scroll work or a wide variety of design alternatives, see the **SPECIAL PRICING APPLICATIONS** section of this catalog.

Please call for special pricing.

BFC Ornamental Iron LIGHT ARISTOCRAT Two Coat



- 1" Square Top & Bottom Rail, 16 ga.
- 5/8" Square Pickets, 18 ga.
- 4" (3 7/8" actual) Spacing Between Pickets
- Power Washed for Paint Preparation
- One Shop Prime Coat
- One Top Coat Black Enamel

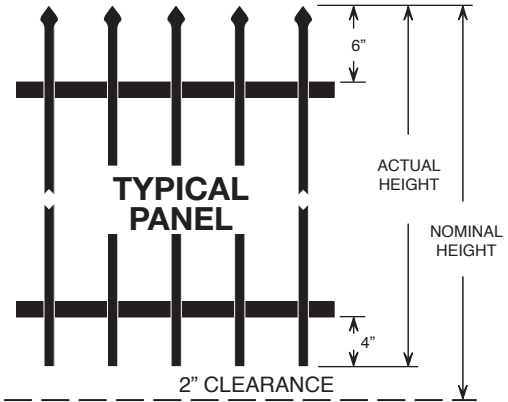

LIGHT ARISTOCRAT, Two Coat, Conventional Sizes

*For black polyurethane top coat add 10% to these prices
For pre-galvanized rail & pickets add 45% to these prices*

Panels

| | Nominal Height Actual Height | 3' 34" | 4' 46" | 5' 58" | 6' 70" |
|-----------------|---------------------------------|-----------|-----------|-----------|-----------|
| 94" length | Item Number | 69010-D | 69110-D | 69210-D | 69310-D |
| | Weight in Pounds | 36 | 44 | 52 | 60 |
| | Price | | | | |
| 120" length | Item Number | 69020-D | 69120-D | 69220-D | 69320-D |
| | Weight in Pounds | 46 | 56 | 66 | 76 |
| | Price | | | | |
| 143 1/2" length | Item Number | 69030-D | 69130-D | 69230-D | 69330-D |
| | Weight in Pounds | 54 | 66 | 78 | 90 |
| | Price | | | | |

Single Gates

Includes standard hardware: an "A-Kit" and an "M-Kit"

| | Nominal Height Actual Height | 3' 34" | 4' 46" | 5' 58" | 6' 70" |
|------------|---------------------------------|-----------|-----------|-----------|-----------|
| 3' opening | Item Number | 69409-D | 69419-D | 69429-D | 69439-D |
| | Weight in Pounds | 17 | 21 | 25 | 30 |
| | Price | | | | |
| 4' opening | Item Number | 69410-D | 69420-D | 69430-D | 69440-D |
| | Weight in Pounds | 20 | 25 | 30 | 35 |
| | Price | | | | |

Double Gates

Includes standard hardware: 2 "A-Kits" and an "R5-Kit"

| | Nominal Height Actual Height | 3' 34" | 4' 46" | 5' 58" | 6' 70" |
|-------------|---------------------------------|-----------|-----------|-----------|-----------|
| 10' opening | Item Number | 69449-D | 69469-D | 69479-D | 69489-D |
| | Weight in Pounds | 53 | 66 | 79 | 92 |
| | Price | | | | |
| 12' opening | Item Number | 69450-D | 69460-D | 69470-D | 69480-D |
| | Weight in Pounds | 60 | 74 | 88 | 102 |
| | Price | | | | |

BFC Ornamental Iron LIGHT ARISTOCRAT Two Coat

LIGHT ARISTOCRAT, Two Coat, Non-Conventional Sizes

PANELS • Item # 69000-D

To determine prices for non-standard sizes, use this list of "per foot" prices.

| | | HEIGHT | | | | | | |
|----------|-----|--------|----|----|----|----|----|----|
| | | 2' | 3' | 4' | 5' | 6' | 7' | 8' |
| per foot | -XX | | | | | | | |

SINGLE GATES • Item # 69400-D

Single Gates include standard hardware: an "A-kit" and an "M-kit".

| | | HEIGHT | | | | | | |
|-------|-----|--------|----|----|----|----|----|----|
| | | 2' | 3' | 4' | 5' | 6' | 7' | 8' |
| WIDTH | 3' | | | | | | | |
| | 4' | | | | | | | |
| | 5' | | | | | | | |
| | 6' | | | | | | | |
| | 7' | | | | | | | |
| | 8' | | | | | | | |
| | 9' | | | | | | | |
| | 10' | | | | | | | |

DOUBLE GATES • Item # 69455-D

Double Gates include standard hardware: 2 "A-kits" and an "R5-kit".

| | | HEIGHT | | | | | | |
|-------|-----|--------|----|----|----|----|----|----|
| | | 2' | 3' | 4' | 5' | 6' | 7' | 8' |
| WIDTH | 6' | | | | | | | |
| | 8' | | | | | | | |
| | 10' | | | | | | | |
| | 12' | | | | | | | |
| | 14' | | | | | | | |
| | 16' | | | | | | | |
| | 18' | | | | | | | |
| | 20' | | | | | | | |

Prices are for rectangular fence and gates only.

For BIAS fence and gates, add \$ per lineal foot.

For TAPERED fence and gates, add \$ per lineal foot.

FOR CUSTOM OPTIONS: arching, scroll work or a wide variety of design alternatives, see the **SPECIAL PRICING APPLICATIONS** section of this catalog.

BFC Ornamental Iron HEAVY ARISTOCRAT Two Coat



- 1 1/2" Square Top & Bottom Rail, 14 ga.
- 3/4" Square Pickets, 16 ga.
- 4" or 5 1/4" Spacing between Pickets
- Power Washed for Paint Preparation
- One Shop Prime Coat
- One Top Coat Black Enamel

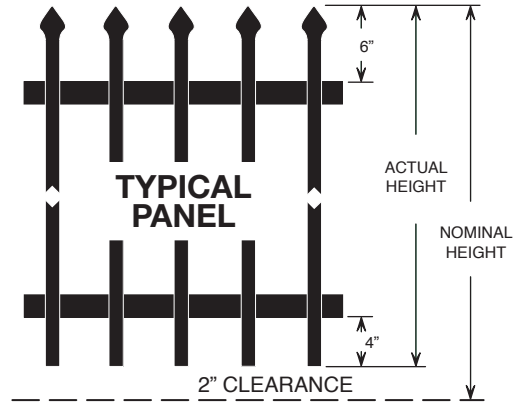

HEAVY ARISTOCRAT, Two Coat,

*For black polyurethane top coat add 10% to these prices
For pre-galvanized rail & pickets add 35% to these prices*

Panels, Conventional Sizes, 4" PICKET SPACING

| | Nominal Height | 5' | 6' | 7' | 8' |
|------------------------|------------------|---------|---------|---------|---------|
| 94" length | Item Number | 80010-D | 80020-D | 80030-D | 80040-D |
| | Weight in Pounds | 78.4 | 90.4 | 101.6 | 113.6 |
| | Price | | | | |
| 118" length | Item Number | 80012-D | 80022-D | 80032-D | 80042-D |
| | Weight in Pounds | 98.0 | 113.0 | 127.0 | 142.0 |
| | Price | | | | |
| 141 3/4" length | Item Number | 80014-D | 80024-D | 80034-D | 80044-D |
| | Weight in Pounds | 117.6 | 135.6 | 152.4 | 170.4 |
| | Price | | | | |

Panels, Conventional Sizes, 5 1/4" PICKET SPACING

| | Nominal Height | 5' | 6' | 7' | 8' |
|------------------------|------------------|---------|---------|---------|---------|
| 94" length | Item Number | 80110-D | 80120-D | 80130-D | 80140-D |
| | Weight in Pounds | 64.8 | 73.6 | 82.4 | 91.2 |
| | Price | | | | |
| 118" length | Item Number | 80112-D | 80122-D | 80132-D | 80142-D |
| | Weight in Pounds | 81.0 | 92.0 | 103.0 | 114.0 |
| | Price | | | | |
| 141 3/4" length | Item Number | 80114-D | 80124-D | 80134-D | 80144-D |
| | Weight in Pounds | 97.2 | 110.4 | 123.6 | 136.8 |
| | Price | | | | |

Panels, Non-Conventional Sizes, per foot

| | Nominal Height | 5' | 6' | 7' | 8' |
|------------------------------|------------------|---------|---------|---------|---------|
| 4" picket spacing | Item Number | 80210-D | 80220-D | 80230-D | 80240-D |
| | Weight in Pounds | 9.8 | 11.3 | 12.7 | 14.2 |
| | Price | | | | |
| 5 1/4" picket spacing | Item Number | 80212-D | 80222-D | 80232-D | 80242-D |
| | Weight in Pounds | 8.1 | 9.2 | 10.3 | 11.4 |
| | Price | | | | |

BFC Ornamental Iron HEAVY ARISTOCRAT Two Coat

HEAVY ARISTOCRAT, Two Coat, Single Gate

Item # 80400-D

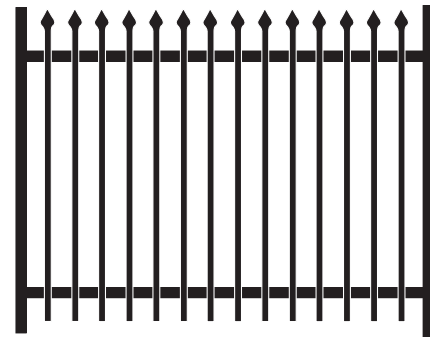
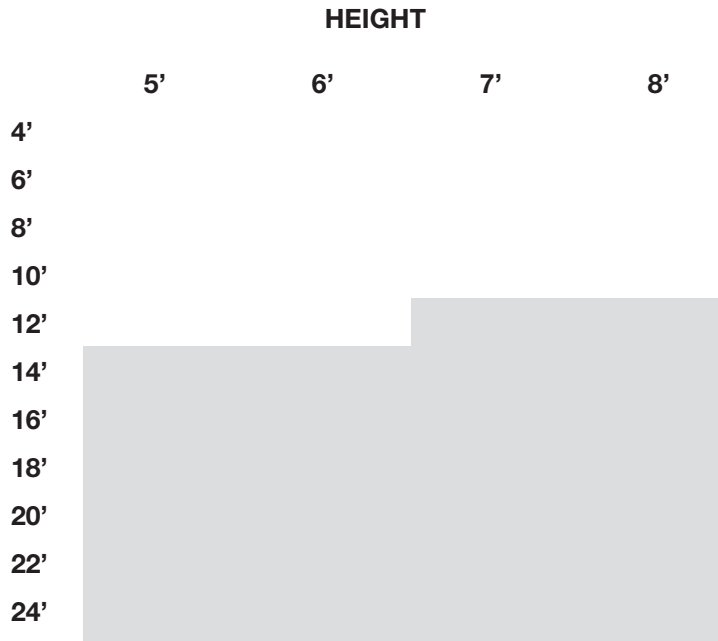

HEAVY ARISTOCRAT, Two Coat, Double Gate

Item # 80450-D

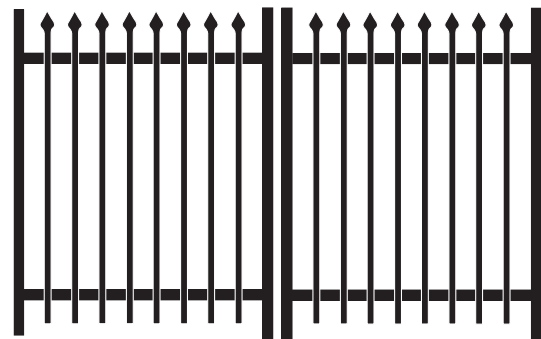
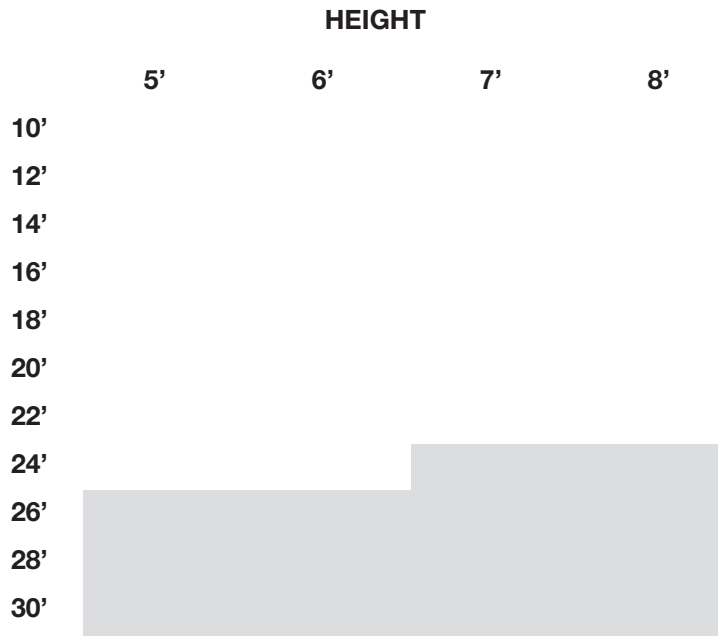

NOTES

Prices listed on this page are based on 4-inch picket spacing only and do not include hardware or trussing. Shaded areas on the pricing schedule indicate gates manufactured with a 2" frame required for additional strength.

FOR CUSTOM OPTIONS: arching, scroll work or a wide variety of design alternatives, see the **SPECIAL PRICING APPLICATIONS** section of this catalog.

Please call for special pricing.

BFC Ornamental Iron HEAVY ARISTOCRAT Two Coat

CONVENTIONAL SLIDE GATE

GATE PRICES INCLUDE:

- 1 5/8" BFC 20 track
- 2 - P.S. pipe track wheels
- 2 - Clamp-on brackets
- 2 - P.S. caps
- 1 - 6" Rubber wheel
- Required track brackets
- Slide gate latch

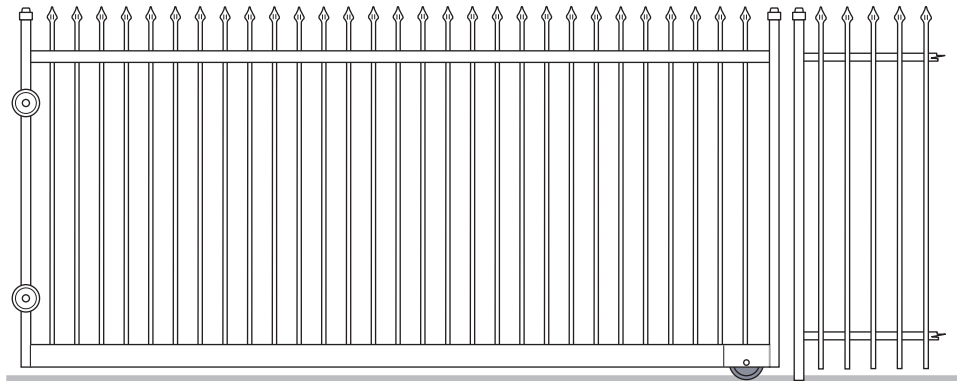

Item # 80474-D

2" x 4" BOTTOM RAIL

Gates are manufactured with 2" top rail and sides with a 2" x 4" bottom rail (4" view), 3/4" sq. pickets and 4" picket spacing. Old style gates with square bottom rail, old style wheel boxes, and pickets on the outside of the rail are available on request.

Call for pricing on custom variations.

End View Detail



- Split Pickets
- Straighter gates because there is no welding on the outside of rails
- Wheel box part of bottom rail

Note: UL 325 requires electronically operated gates and the fence line adjoining such gates to have a maximum 2 1/8" picket spacing or mesh installed. For additional cost, contact sales person.

HEAVY ARISTOCRAT, Two Coat, Conventional Slide Gate

HEIGHT

| | 3' | 4' | 5' | 6' |
|---|-----|----|----|----|
| O | 8' | | | |
| P | 10' | | | |
| E | 12' | | | |
| N | 14' | | | |
| I | 16' | | | |
| N | 18' | | | |
| G | 20' | | | |

FOR CUSTOM OPTIONS: arching, scroll work or a wide variety of design alternatives, see the **SPECIAL PRICING APPLICATIONS** section of this catalog.

Please call for special pricing.

BFC Ornamental Iron HEAVY ARISTOCRAT Two Coat

OVERHEAD ROLLER STYLE

End View
Detail

GATE PRICES INCLUDE:

- 2 - P.S. caps
- 1 - Roller assembly
- 1 - Industrial slide latch
- 2 - 6" V-Groove wheels
- V-Track with J-bolts or Tabs

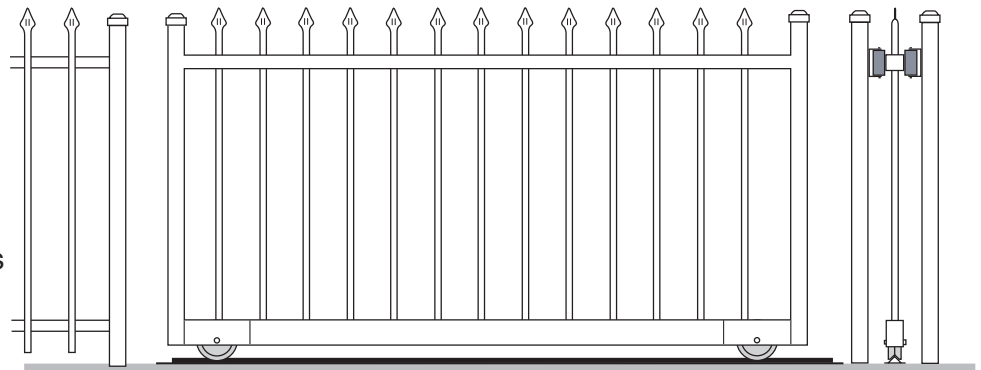

End View Detail

- Split Pickets

Item # 80475-D

2" x 4" BOTTOM RAIL



- Straighter gates because there is no welding on the outside of rails
- No strap needed across the pickets
- Wheel box part of bottom rail

Gates are manufactured with 2" top rail and sides with a 2" x 4" bottom rail (4" view), 3/4" sq. pickets and 4" picket spacing. Old style gates with square bottom rail, old style wheel boxes, and pickets on the outside of the rail are available on request. Call for pricing on custom variations. Shaded areas on the pricing schedule indicate gates manufactured with an 11 gauge frame required for additional strength. Trussing is optional and may be required for larger gates sizes. Refer to SPECIAL PRICING APPLICATION section.

Note: UL 325 requires electronically operated gates and the fence line adjoining such gates to have a maximum 2 1/8" picket spacing or mesh installed. For additional cost, contact sales person.

HEAVY ARISTOCRAT, Two Coat, Overhead Roller Assembly Style Slide Gate

| | | HEIGHT | | | | | |
|---|-----|--------|----|----|----|----|----|
| | | 3' | 4' | 5' | 6' | 7' | 8' |
| | 10' | | | | | | |
| O | 12' | | | | | | |
| P | 14' | | | | | | |
| E | 16' | | | | | | |
| N | 18' | | | | | | |
| I | 20' | | | | | | |
| N | 22' | | | | | | |
| G | 24' | | | | | | |
| | 26' | | | | | | |
| | 28' | | | | | | |
| | 30' | | | | | | |

FOR CUSTOM OPTIONS: arching, scroll work or a wide variety of design alternatives, see the **SPECIAL PRICING APPLICATIONS** section of this catalog.

Please call for special pricing.

BFC Ornamental Iron

HEAVY GUARDIAN
Two Coat

PICKET POSITION

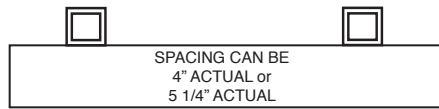

- 1 1/2" Square Top & Bottom Rail, 14 ga.
- 3/4" Square Pickets, 16 ga.
- 4" or 5 1/4" Spacing between Pickets
- Power Washed for Paint Preparation
- One Shop Prime Coat
- One Top Coat Black Enamel

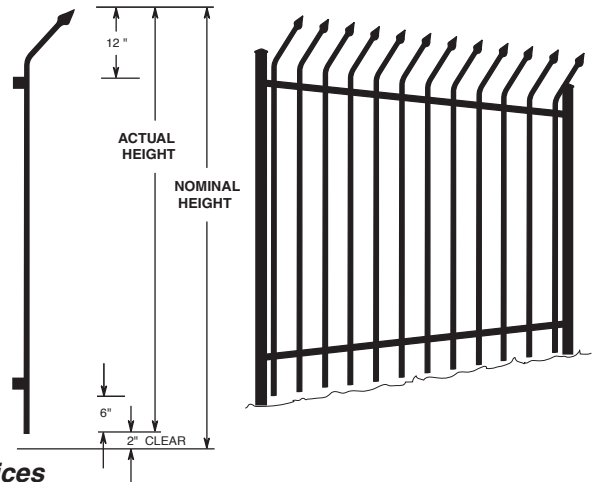

HEAVY GUARDIAN, Two Coat,

*For black polyurethane top coat add 10% to these prices
For pre-galvanized rail & pickets add 35% to these prices*

Panels, Conventional Sizes, 4" PICKET SPACING

| Nominal Height | | 7' | 8' | 9' | 10' |
|-----------------|------------------|---------|---------|---------|---------|
| 94" length | Item Number | 81010-D | 81020-D | 81030-D | 81040-D |
| | Weight in Pounds | 105.6 | 117.6 | 128.8 | 140.8 |
| | Price | | | | |
| 118" length | Item Number | 81012-D | 81022-D | 81032-D | 81042-D |
| | Weight in Pounds | 132.0 | 147.0 | 161.0 | 176.0 |
| | Price | | | | |
| 141 3/4" length | Item Number | 81014-D | 81024-D | 81034-D | 81044-D |
| | Weight in Pounds | 158.4 | 176.4 | 193.2 | 211.2 |
| | Price | | | | |

Panels, Conventional Sizes, 5 1/4" PICKET SPACING

| Nominal Height | | 7' | 8' | 9' | 10' |
|-----------------|------------------|---------|---------|---------|---------|
| 94" length | Item Number | 81110-D | 81120-D | 81130-D | 81140-D |
| | Weight in Pounds | 88.8 | 98.4 | 108.0 | 116.8 |
| | Price | | | | |
| 118" length | Item Number | 81112-D | 81122-D | 81132-D | 81142-D |
| | Weight in Pounds | 111.0 | 123.0 | 135.0 | 146.0 |
| | Price | | | | |
| 141 3/4" length | Item Number | 81114-D | 81124-D | 81134-D | 81144-D |
| | Weight in Pounds | 133.2 | 147.6 | 162.0 | 175.2 |
| | Price | | | | |

Panels, Non-Conventional Sizes, per foot

| Nominal Height | | 7' | 8' | 9' | 10' |
|-----------------------|------------------|---------|---------|---------|---------|
| 4" picket spacing | Item Number | 81210-D | 81220-D | 81230-D | 81240-D |
| | Weight in Pounds | 13.2 | 14.7 | 16.1 | 17.6 |
| | Price | | | | |
| 5 1/4" picket spacing | Item Number | 81212-D | 81222-D | 81232-D | 81242-D |
| | Weight in Pounds | 11.1 | 12.3 | 13.5 | 14.6 |
| | Price | | | | |

The shaded items are too large to be Factory painted, they are furnished not cleaned of mill oil and not painted.

HEAVY GUARDIAN, Two Coat, Single Gate

Item # 81400-D

| | | HEIGHT | | | |
|--|--|--------|----|----|-------|
| | | 7' | 8' | 9' | * 10' |
| 4' 6' 8' 10' 12' 14' 16' 18' 20' 22' 24' | | | | | * |
| | | | | | * |
| | | | | | * |
| | | | | | * |
| | | | | | * |
| | | | | | * |
| | | | | | * |
| | | | | | * |
| | | | | | * |
| | | | | | * |

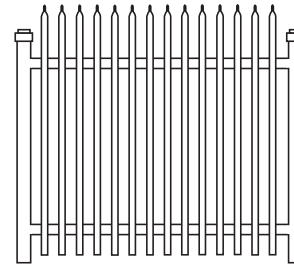

HEAVY GUARDIAN, Two Coat, Double Gate

Item # 81450-D

| | | HEIGHT | | | |
|---|--|--------|----|----|-------|
| | | 7' | 8' | 9' | * 10' |
| 10' 12' 14' 16' 18' 20' 22' 24' 26' 28' 30' | | | | | * |
| | | | | | * |
| | | | | | * |
| | | | | | * |
| | | | | | * |
| | | | | | * |
| | | | | | * |
| | | | | | * |
| | | | | | * |
| | | | | | * |

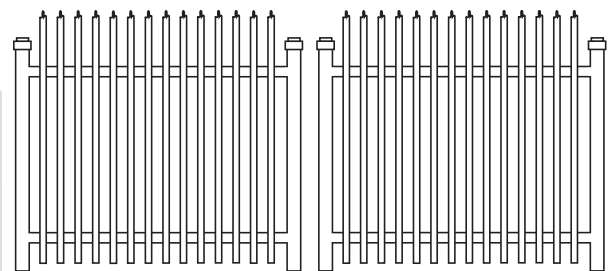

NOTES

Prices listed on this page are based on 4-inch picket spacing only and do not include hardware or trussing. Shaded areas on the pricing schedule indicate gates manufactured with a 2" frame required for additional strength.

FOR CUSTOM OPTIONS: arching, scroll work or a wide variety of design alternatives, see the **SPECIAL PRICING APPLICATIONS** section of this catalog.

* All 10' Guardian swing gates over 9' in width are too large to be factory painted. They are furnished not cleaned of mill oil and not painted.

CONVENTIONAL SLIDE GATE

GATE PRICES INCLUDE:

- 1 5/8" BFC 20 track
- 2 - P.S. pipe track wheels
- 2 - Clamp-on brackets
- 2 - P.S. caps
- 1 - 6" Rubber wheel
- Required track brackets
- Slide gate latch

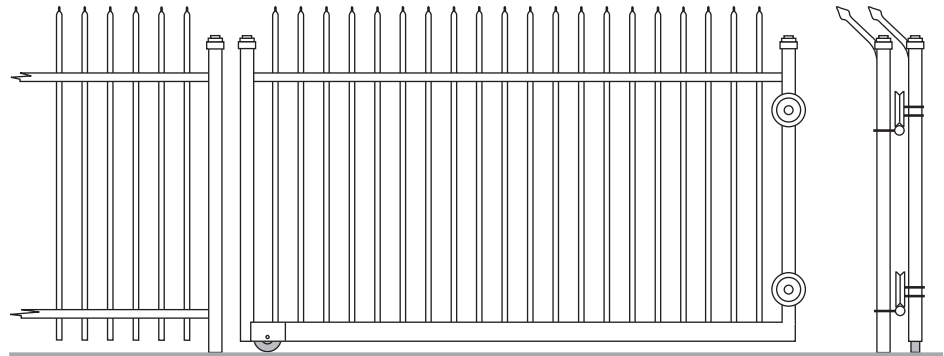

Item # 81474-D

2" x 4" BOTTOM RAIL

Gates are manufactured with 2" top rail and sides with a 2" x 4" bottom rail (4" view), 3/4" sq. pickets and 4" picket spacing. Old style gates with square bottom rail, old style wheel boxes, and pickets on the outside of the rail are available on request.

Call for pricing on custom variations.

End View Detail

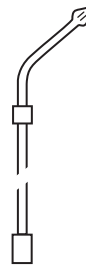

- Split Pickets
- Straighter gates because there is no welding on the outside of rails
- Wheel box part of bottom rail

Note: UL 325 requires electronically operated gates and the fence line adjoining such gates to have a maximum 2 1/8" picket spacing or mesh installed. For additional cost, contact sales person.

HEAVY GUARDIAN, Two Coat, Conventional Slide Gate

| | | HEIGHT | | |
|---|-----|--------|----|----|
| O | | 7' | 8' | 9' |
| P | | | | |
| E | 10' | | | |
| N | 12' | | | |
| I | 14' | | | |
| N | 16' | | | |
| G | | | | |

FOR CUSTOM OPTIONS: arching, scroll work or a wide variety of design alternatives, see the **SPECIAL PRICING APPLICATIONS** section of this catalog.

Please call for special pricing.

OVERHEAD ROLLER STYLE

GATE PRICES INCLUDE:

- 2 - P.S. caps
- 1 - Roller assembly
- 1 - Industrial slide latch
- 2 - 6" V-Groove wheels
- V-Track with J-bolts or Tabs

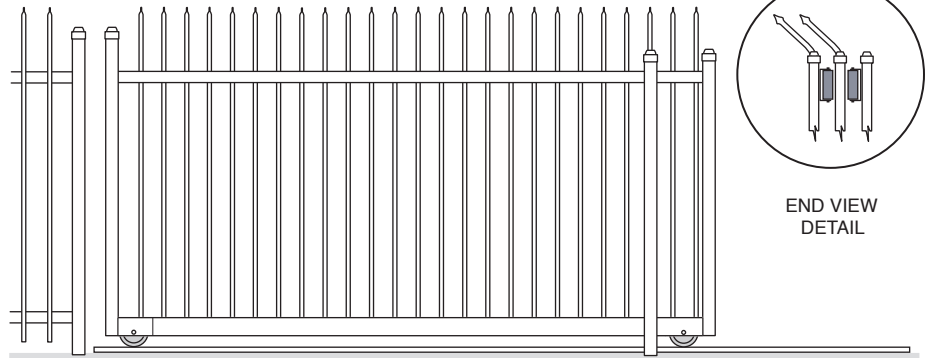

End View Detail

- Split Pickets
- Straighter gates because there is no welding on the outside of rails
- No strap needed across the pickets
- Wheel box part of bottom rail

Item # 81475-D

2" x 4" BOTTOM RAIL

Gates are manufactured with 2" top rail and sides with a 2" x 4" bottom rail (4" view), 3/4" sq. pickets and 4" picket spacing. Old style gates with square bottom rail, old style wheel boxes, and pickets on the outside of the rail are available on request. Call for pricing on custom variations. Shaded areas on the pricing schedule indicate gates manufactured with an 11 gauge frame required for additional strength. Trussing is optional and may be required for larger gates sizes. Refer to SPECIAL PRICING APPLICATION section.

Note: UL 325 requires electronically operated gates and the fence line adjoining such gates to have a maximum 2 1/8" picket spacing or mesh installed. For additional cost, contact sales person.

HEAVY GUARDIAN, Two Coat, Overhead Roller Assembly Style Slide Gate

| | | HEIGHT | | | |
|---|-----|--------|----|----|-------|
| | | 7' | 8' | 9' | * 10' |
| | 10' | | | | * |
| O | 12' | | | | * |
| P | 14' | | | | * |
| E | 16' | | | | * |
| N | 18' | | | | * |
| I | 20' | | | | * |
| N | 22' | | | | * |
| G | 24' | | | | * |
| | 26' | | | | * |
| | 28' | | | | * |
| | 30' | | | | * |

* All 10' Guardian slide gates over 9' in width are too large to be factory painted. They are furnished not cleaned of mill oil and not painted.

FOR CUSTOM OPTIONS: arching, scroll work or a wide variety of design alternatives, see the **SPECIAL PRICING APPLICATIONS** section of this catalog.

BFC Ornamental Iron

LIGHT EMPIRE
Two Coat

PICKET POSITION

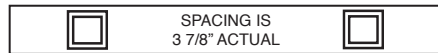

- 1" Square Top & Bottom Rail, 16 ga.
- 5/8" Square Pickets, 18 ga.
- 4" (3 7/8" actual) Spacing Between Pickets
- Power Washed for Paint Preparation
- One Shop Prime Coat
- One Top Coat Black Enamel

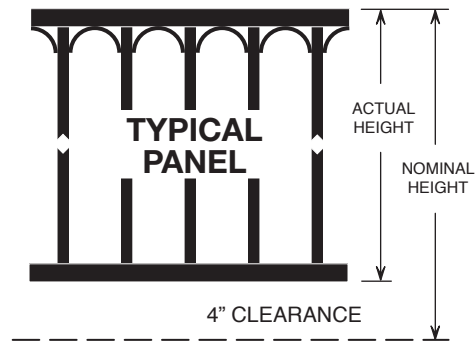

LIGHT EMPIRE, Two Coat, Conventional Sizes

For black polyurethane top coat add 10% to these prices

For pre-galvanized rail & pickets add 45% to these prices

Panels

| | Nominal Height Actual Height | 3' 32" | 4' 44" | 5' 56" | 6' 68" |
|-----------------|---------------------------------|-----------|-----------|-----------|-----------|
| 94" length | Item Number | 75010-D | 75110-D | 75210-D | 75310-D |
| | Weight in Pounds | 38 | 46 | 54 | 62 |
| | Price | | | | |
| 120" length | Item Number | 75020-D | 75120-D | 75220-D | 75320-D |
| | Weight in Pounds | 49 | 59 | 69 | 79 |
| | Price | | | | |
| 143 1/2" length | Item Number | 75030-D | 75130-D | 75230-D | 75330-D |
| | Weight in Pounds | 58 | 70 | 82 | 90 |
| | Price | | | | |

Single Gates

Includes standard hardware: an "A-Kit" and an "M-Kit"

| | Nominal Height Actual Height | 3' 32" | 4' 44" | 5' 56" | 6' 68" |
|------------|---------------------------------|-----------|-----------|-----------|-----------|
| 3' opening | Item Number | 75409-D | 75419-D | 75429-D | 75439-D |
| | Weight in Pounds | 18 | 22 | 26 | 31 |
| | Price | | | | |
| 4' opening | Item Number | 75410-D | 75420-D | 75430-D | 75440-D |
| | Weight in Pounds | 21 | 26 | 31 | 36 |
| | Price | | | | |

Double Gates

Includes standard hardware: 2 "A-Kits" and an "R5-Kit"

| | Nominal Height Actual Height | 3' 32" | 4' 44" | 5' 56" | 6' 68" |
|-------------|---------------------------------|-----------|-----------|-----------|-----------|
| 10' opening | Item Number | 75449-D | 75459-D | 75469-D | 75479-D |
| | Weight in Pounds | 56 | 68 | 81 | 94 |
| | Price | | | | |
| 12' opening | Item Number | 75450-D | 75460-D | 75470-D | 75480-D |
| | Weight in Pounds | 63 | 77 | 91 | 105 |
| | Price | | | | |

BFC Ornamental Iron

LIGHT EMPIRE
Two Coat

LIGHT EMPIRE, Two Coat, Non-Conventional Sizes

PANELS • Item # 75000-D

To determine prices for non-standard sizes, use this list of "per foot" prices.

| | | HEIGHT | | | | | | |
|----------|-----|--------|----|----|----|----|----|----|
| | | 2' | 3' | 4' | 5' | 6' | 7' | 8' |
| per foot | -XX | | | | | | | |

SINGLE GATES • Item # 75400-D

Single Gates include standard hardware: an "A-kit" and an "M-kit".

| | | HEIGHT | | | | | | |
|-------|-----|--------|----|----|----|----|----|----|
| | | 2' | 3' | 4' | 5' | 6' | 7' | 8' |
| WIDTH | 3' | | | | | | | |
| | 4' | | | | | | | |
| | 5' | | | | | | | |
| | 6' | | | | | | | |
| | 7' | | | | | | | |
| | 8' | | | | | | | |
| | 9' | | | | | | | |
| | 10' | | | | | | | |

DOUBLE GATES • Item # 75455-D

Double Gates include standard hardware: 2 "A-kits" and an "R5-kit".

| | | HEIGHT | | | | | | |
|-------|-----|--------|----|----|----|----|----|----|
| | | 2' | 3' | 4' | 5' | 6' | 7' | 8' |
| WIDTH | 6' | | | | | | | |
| | 8' | | | | | | | |
| | 10' | | | | | | | |
| | 12' | | | | | | | |
| | 14' | | | | | | | |
| | 16' | | | | | | | |
| | 18' | | | | | | | |
| | 20' | | | | | | | |

Prices are for rectangular fence and gates only.

For BIAS fence and gates, add \$ per lineal foot.

For TAPERED fence and gates, add \$ per lineal foot.

FOR CUSTOM OPTIONS: arching, scroll work or a wide variety of design alternatives, see the **SPECIAL PRICING APPLICATIONS** section of this catalog.

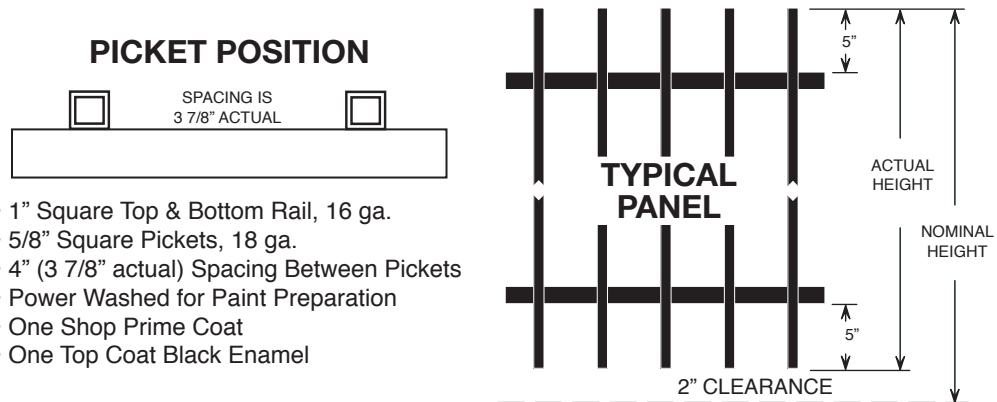

- 1" Square Top & Bottom Rail, 16 ga.
- 5/8" Square Pickets, 18 ga.
- 4" (3 7/8" actual) Spacing Between Pickets
- Power Washed for Paint Preparation
- One Shop Prime Coat
- One Top Coat Black Enamel

BFC recommends that plastic plug caps be installed at both ends of open pickets. Add cents per foot. Caps shipped loose. Request when ordering.

LIGHT MODERN, Two Coat, Conventional Sizes

For black polyurethane top coat add 10% to these prices

For pre-galvanized rail & pickets add 45% to these prices

Panels

| | Nominal Height Actual Height | 3' 34" | 4' 46" | 5' 58" | 6' 70" |
|------------------------|---------------------------------|-----------|-----------|-----------|-----------|
| 94" length | Item Number | 76010-D | 76110-D | 76210-D | 76310-D |
| | Weight in Pounds | 36 | 44 | 52 | 60 |
| | Price | | | | |
| 120" length | Item Number | 76020-D | 76120-D | 76220-D | 76320-D |
| | Weight in Pounds | 46 | 56 | 66 | 76 |
| | Price | | | | |
| 143 1/2" length | Item Number | 76030-D | 76130-D | 76230-D | 76330-D |
| | Weight in Pounds | 54 | 66 | 78 | 90 |
| | Price | | | | |

Single Gates

Includes standard hardware: an "A-Kit" and an "M-Kit"

| | Nominal Height Actual Height | 3' 34" | 4' 46" | 5' 58" | 6' 70" |
|-------------------|---------------------------------|-----------|-----------|-----------|-----------|
| 3' opening | Item Number | 76409-D | 76419-D | 76429-D | 76439-D |
| | Weight in Pounds | 17 | 21 | 25 | 30 |
| | Price | | | | |
| 4' opening | Item Number | 76410-D | 76420-D | 76430-D | 76440-D |
| | Weight in Pounds | 20 | 25 | 30 | 35 |
| | Price | | | | |

Double Gates

Includes standard hardware: 2 "A-Kits" and an "R5-Kit"

| | Nominal Height Actual Height | 3' 34" | 4' 46" | 5' 58" | 6' 70" |
|--------------------|---------------------------------|-----------|-----------|-----------|-----------|
| 10' opening | Item Number | 76449-D | 76459-D | 76469-D | 76479-D |
| | Weight in Pounds | 53 | 66 | 79 | 92 |
| | Price | | | | |
| 12' opening | Item Number | 76450-D | 76460-D | 76470-D | 76480-D |
| | Weight in Pounds | 60 | 74 | 88 | 102 |
| | Price | | | | |

BFC Ornamental Iron

LIGHT MODERN
Two Coat

LIGHT MODERN, Two Coat, Non-Conventional Sizes

PANELS • Item # 76000-D

To determine prices for non-standard sizes, use this list of "per foot" prices.

| | | HEIGHT | | | | | | |
|----------|-----|--------|----|----|----|----|----|----|
| | | 2' | 3' | 4' | 5' | 6' | 7' | 8' |
| per foot | -XX | | | | | | | |

SINGLE GATES • Item # 76400-D

Single Gates include standard hardware: an "A-kit" and an "M-kit".

| | | HEIGHT | | | | | | |
|-------|-----|--------|----|----|----|----|----|----|
| | | 2' | 3' | 4' | 5' | 6' | 7' | 8' |
| WIDTH | 3' | | | | | | | |
| | 4' | | | | | | | |
| | 5' | | | | | | | |
| | 6' | | | | | | | |
| | 7' | | | | | | | |
| | 8' | | | | | | | |
| | 9' | | | | | | | |
| | 10' | | | | | | | |

DOUBLE GATES • Item # 75455-D

Double Gates include standard hardware: 2 "A-kits" and an "R5-kit".

| | | HEIGHT | | | | | | |
|-------|-----|--------|----|----|----|----|----|----|
| | | 2' | 3' | 4' | 5' | 6' | 7' | 8' |
| WIDTH | 6' | | | | | | | |
| | 8' | | | | | | | |
| | 10' | | | | | | | |
| | 12' | | | | | | | |
| | 14' | | | | | | | |
| | 16' | | | | | | | |
| | 18' | | | | | | | |
| | 20' | | | | | | | |

Prices are for rectangular fence and gates only.

For BIAS fence and gates, add \$ per lineal foot.

For TAPERED fence and gates, add \$ per lineal foot.

FOR CUSTOM OPTIONS: arching, scroll work or a wide variety of design alternatives, see the **SPECIAL PRICING APPLICATIONS** section of this catalog.

BFC Ornamental Iron

LIGHT NAPOLEON
Two Coat

PICKET POSITION

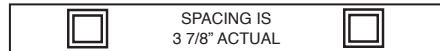

- 1" Square Top & Bottom Rail, 16 ga.
- 5/8" Square Pickets, 18 ga.
- 4" (3 7/8" actual) Spacing Between Pickets
- Power Washed for Paint Preparation
- One Shop Prime Coat
- One Top Coat Black Enamel

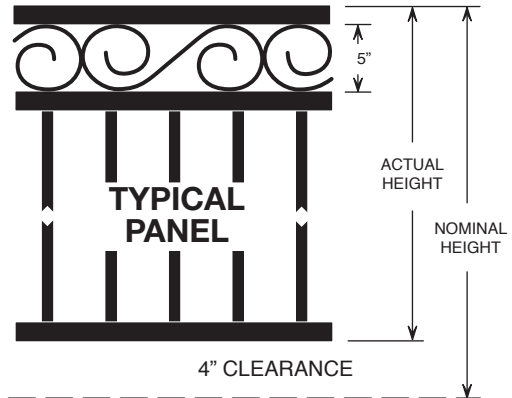

LIGHT NAPOLEON, Two Coat, Conventional Sizes

For black polyurethane top coat add 10% to these prices

For pre-galvanized rail & pickets add 45% to these prices

Panels

| | Nominal Height Actual Height | 3' 32" | 4' 44" | 5' 56" | 6' 68" |
|-----------------|---------------------------------|-----------|-----------|-----------|-----------|
| 94" length | Item Number | 73010-D | 73110-D | 73210-D | 73310-D |
| | Weight in Pounds | 40 | 48 | 56 | 64 |
| 120" length | Item Number | 73020-D | 73120-D | 73220-D | 73320-D |
| | Weight in Pounds | 52 | 62 | 72 | 82 |
| 143 1/2" length | Item Number | 73030-D | 73130-D | 73230-D | 73330-D |
| | Weight in Pounds | 63 | 75 | 87 | 99 |

Single Gates

Includes standard hardware: an "A-Kit" and an "M-Kit"

| | Nominal Height Actual Height | 3' 32" | 4' 44" | 5' 56" | 6' 68" |
|------------|---------------------------------|-----------|-----------|-----------|-----------|
| 3' opening | Item Number | 73409-D | 73419-D | 73429-D | 73439-D |
| | Weight in Pounds | 21 | 25 | 29 | 33 |
| 4' opening | Item Number | 73410-D | 73420-D | 73430-D | 73440-D |
| | Weight in Pounds | 26 | 31 | 36 | 41 |

Double Gates

Includes standard hardware: 2 "A-Kits" and an "R5-Kit"

| | Nominal Height Actual Height | 3' 32" | 4' 44" | 5' 56" | 6' 68" |
|-------------|---------------------------------|-----------|-----------|-----------|-----------|
| 10' opening | Item Number | 73449-D | 73459-D | 73469-D | 73479-D |
| | Weight in Pounds | 60 | 72 | 84 | 96 |
| 12' opening | Item Number | 73450-D | 73460-D | 73470-D | 73480-D |
| | Weight in Pounds | 72 | 86 | 100 | 114 |

BFC Ornamental Iron

LIGHT NAPOLEON
Two Coat

LIGHT NAPOLEON, Two Coat, Non-Conventional Sizes

PANELS • Item # 73000-D

To determine prices for non-standard sizes, use this list of "per foot" prices.

| | | HEIGHT | | | | | | |
|----------|-----|--------|----|----|----|----|----|----|
| | | 2' | 3' | 4' | 5' | 6' | 7' | 8' |
| per foot | -XX | | | | | | | |

SINGLE GATES • Item # 73400-D

Single Gates include standard hardware: an "A-kit" and an "M-kit".

| | | HEIGHT | | | | | | |
|-------|-----|--------|----|----|----|----|----|----|
| | | 2' | 3' | 4' | 5' | 6' | 7' | 8' |
| WIDTH | 3' | | | | | | | |
| | 4' | | | | | | | |
| | 5' | | | | | | | |
| | 6' | | | | | | | |
| | 7' | | | | | | | |
| | 8' | | | | | | | |
| | 9' | | | | | | | |
| | 10' | | | | | | | |

DOUBLE GATES • Item # 73455-D

Double Gates include standard hardware: 2 "A-kits" and an "R5-kit".

| | | HEIGHT | | | | | | |
|-------|-----|--------|----|----|----|----|----|----|
| | | 2' | 3' | 4' | 5' | 6' | 7' | 8' |
| WIDTH | 6' | | | | | | | |
| | 8' | | | | | | | |
| | 10' | | | | | | | |
| | 12' | | | | | | | |
| | 14' | | | | | | | |
| | 16' | | | | | | | |
| | 18' | | | | | | | |
| | 20' | | | | | | | |

Prices are for rectangular fence and gates only.

For BIAS fence and gates, add \$ per lineal foot.

For TAPERED fence and gates, add \$ per lineal foot.

FOR CUSTOM OPTIONS: arching, scroll work or a wide variety of design alternatives, see the **SPECIAL PRICING APPLICATIONS** section of this catalog.

BFC Ornamental Iron

LIGHT REGAL
One Coat

PICKET POSITION

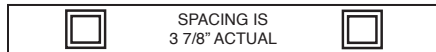

- 1" Square Top & Bottom Rail, 16 ga.
- 5/8" Square Pickets, 18 ga.
- 4" (3 7/8" actual) Spacing between Pickets
- Power Washed for Paint Preparation
- One Prime Coat Black

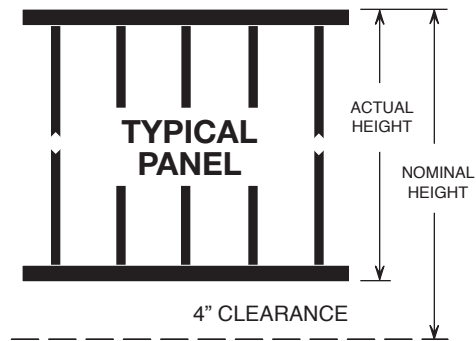

LIGHT REGAL, One Coat, Conventional Sizes

Panels

| | Nominal Height Actual Height | 3' 32" | 3 1/2' 38" | 4' 44" | 5' 56" | SPECIAL 58" | 6' 68" |
|------------------------|---------------------------------|-----------|---------------|-----------|-----------|----------------|-----------|
| 94" length | Item Number | 68010-S | 68040-S | 68110-S | 68210-S | 68240-S | 68310-S |
| | Weight in Pounds | 33 | 37 | 41 | 49 | 51 | 57 |
| 120" length | Item Number | 68020-S | 68050-S | 68120-S | 68220-S | 68250-S | 68320-S |
| | Weight in Pounds | 42 | 47 | 52 | 62 | 64 | 72 |
| 143 1/2" length | Item Number | 68030-S | 68060-S | 68130-S | 68230-S | 68260-S | 68330-S |
| | Weight in Pounds | 50 | 56 | 62 | 74 | 77 | 86 |

Single Gates

Includes standard hardware: an "A-Kit" and an "M-Kit"

| | Nominal Height Actual Height | 3' 32" | 3 1/2' 38" | 4' 44" | 5' 56" | SPECIAL 58" | 6' 68" |
|-------------------|---------------------------------|-----------|---------------|-----------|-----------|----------------|-----------|
| 3' opening | Item Number | 68409-S | 68414-S | 68419-S | 68429-S | 68435-S | 68439-S |
| | Weight in Pounds | 16 | 18 | 20 | 24 | 25 | 29 |
| 4' opening | Item Number | 68410-S | 68415-S | 68420-S | 68430-S | 68436-S | 68440-S |
| | Weight in Pounds | 19 | 22 | 24 | 29 | 31 | 34 |

Double Gates

Includes standard hardware: 2 "A-Kits" and an "R5-Kit"

| | Nominal Height Actual Height | 3' 32" | 3 1/2' 38" | 4' 44" | 5' 56" | SPECIAL 58" | 6' 68" |
|--------------------|---------------------------------|-----------|---------------|-----------|-----------|----------------|-----------|
| 10' opening | Item Number | 68449-S | 68454-S | 68459-S | 68469-S | 68485-S | 68479-SS |
| | Weight in Pounds | 49 | 55 | 62 | 75 | 78 | 88 |
| 12' opening | Item Number | 68450-S | 68455-S | 68460-S | 68470-S | 68487-S | 68480-S |
| | Weight in Pounds | 56 | 63 | 70 | 84 | 87 | 98 |

BFC Ornamental Iron

LIGHT REGAL
One Coat

LIGHT REGAL, One Coat, Non-Conventional Sizes

PANELS • Item # 68000-S

To determine prices for non-standard sizes, use this list of "per foot" prices.

| | | HEIGHT | | | | | |
|----------|-----|--------|----|--------|----|----|----|
| | | 2' | 3' | 3 1/2' | 4' | 5' | 6' |
| per foot | -XX | | | | | | |

SINGLE GATES • Item # 68400-S

Single Gates include standard hardware: an "A-kit" and an "M-kit".

| | | HEIGHT | | | | | |
|-------|-----|--------|----|--------|----|----|----|
| | | 2' | 3' | 3 1/2' | 4' | 5' | 6' |
| WIDTH | 3' | | | | | | |
| | 4' | | | | | | |
| | 5' | | | | | | |
| | 6' | | | | | | |
| | 7' | | | | | | |
| | 8' | | | | | | |
| | 9' | | | | | | |
| | 10' | | | | | | |

DOUBLE GATES • Item # 68450-S

Double Gates include standard hardware: 2 "A-kits" and an "R5-kit".

| | | HEIGHT | | | | | |
|-------|-----|--------|----|--------|----|----|----|
| | | 2' | 3' | 3 1/2' | 4' | 5' | 6' |
| WIDTH | 6' | | | | | | |
| | 8' | | | | | | |
| | 10' | | | | | | |
| | 12' | | | | | | |
| | 14' | | | | | | |
| | 16' | | | | | | |
| | 18' | | | | | | |
| | 20' | | | | | | |

Prices are for rectangular fence and gates only.
 For BIAS fence and gates, add \$ per lineal foot.
 For TAPERED fence and gates, add \$ per lineal foot.
 Biasable fence panels in standard sizes are available, see biasable price page 48.

FOR CUSTOM OPTIONS: arching, scroll work or a wide variety of design alternatives, see the **SPECIAL PRICING APPLICATIONS** section of this catalog.

BFC Ornamental Iron LIGHT ARISTOCRAT One Coat

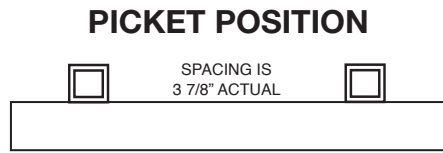

- 1" Square Top & Bottom Rail, 16 ga.
- 5/8" Square Pickets, 18 ga.
- 4" (3 7/8" actual) Spacing Between Pickets
- Power Washed for Paint Preparation
- One Prime Coat Black

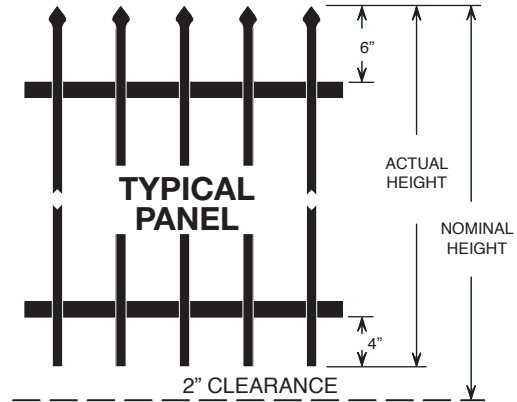

LIGHT ARISTOCRAT, One Coat, Conventional Sizes

Panels

| | Nominal Height Actual Height | 3' 34" | 4' 46" | 5' 58" | 6' 70" |
|------------------------|---------------------------------|-----------|-----------|-----------|-----------|
| 94" length | Item Number | 69010-S | 69110-S | 69210-S | 69310-S |
| | Weight in Pounds | 36 | 44 | 52 | 60 |
| 120" length | Item Number | 69020-S | 69120-S | 69220-S | 69320-S |
| | Weight in Pounds | 46 | 56 | 66 | 76 |
| 143 1/2" length | Item Number | 69030-S | 69130-S | 69230-S | 69330-S |
| | Weight in Pounds | 54 | 66 | 78 | 90 |
| | Price | | | | |

Single Gates

Includes standard hardware: an "A-Kit" and an "M-Kit"

| | Nominal Height Actual Height | 3' 34" | 4' 46" | 5' 58" | 6' 70" |
|-------------------|---------------------------------|-----------|-----------|-----------|-----------|
| 3' opening | Item Number | 69409-S | 69419-S | 69429-S | 69439-S |
| | Weight in Pounds | 17 | 21 | 25 | 30 |
| 4' opening | Item Number | 69410-S | 69420-S | 69430-S | 69440-S |
| | Weight in Pounds | 20 | 25 | 30 | 35 |
| | Price | | | | |

Double Gates

Includes standard hardware: 2 "A-Kits" and an "R5-Kit"

| | Nominal Height Actual Height | 3' 34" | 4' 46" | 5' 58" | 6' 70" |
|--------------------|---------------------------------|-----------|-----------|-----------|-----------|
| 10' opening | Item Number | 69459-S | 69469-S | 69479-S | 69489-S |
| | Weight in Pounds | 53 | 66 | 79 | 92 |
| 12' opening | Item Number | 69460-S | 69470-S | 69480-S | 69490-S |
| | Weight in Pounds | 60 | 74 | 88 | 102 |
| | Price | | | | |

BFC Ornamental Iron LIGHT ARISTOCRAT One Coat

LIGHT ARISTOCRAT, One Coat, Non-Conventional Sizes

PANELS • Item # 69000-S

To determine prices for non-standard sizes, use this list of "per foot" prices.

| | | HEIGHT | | | | |
|----------|-----|--------|----|----|----|----|
| | | 2' | 3' | 4' | 5' | 6' |
| per foot | -XX | | | | | |

SINGLE GATES • Item # 69400-S

Single Gates include standard hardware: an "A-kit" and an "M-kit".

| | | HEIGHT | | | | |
|-------|-----|--------|----|----|----|----|
| | | 2' | 3' | 4' | 5' | 6' |
| WIDTH | 3' | | | | | |
| | 4' | | | | | |
| | 5' | | | | | |
| | 6' | | | | | |
| | 7' | | | | | |
| | 8' | | | | | |
| | 9' | | | | | |
| | 10' | | | | | |

DOUBLE GATES • Item # 69450-S

Double Gates include standard hardware: 2 "A-kits" and an "R5-kit".

| | | HEIGHT | | | | |
|-------|-----|--------|----|----|----|----|
| | | 2' | 3' | 4' | 5' | 6' |
| WIDTH | 6' | | | | | |
| | 8' | | | | | |
| | 10' | | | | | |
| | 12' | | | | | |
| | 14' | | | | | |
| | 16' | | | | | |
| | 18' | | | | | |
| | 20' | | | | | |

Prices are for rectangular fence and gates only.
 For BIAS fence and gates, add \$ per lineal foot.
 For TAPERED fence and gates, add \$ per lineal foot.

FOR CUSTOM OPTIONS: arching, scroll work or a wide variety of design alternatives, see the **SPECIAL PRICING APPLICATIONS** section of this catalog.

PICKET POSITION

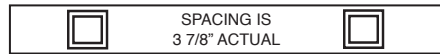

- 1" Square Top & Bottom Rail, 16 ga.
- 5/8" Square Pickets, 18 ga.
- 4" (3 7/8" actual) Spacing Between Pickets
- Power Washed for Paint Preparation
- One Prime Coat Black

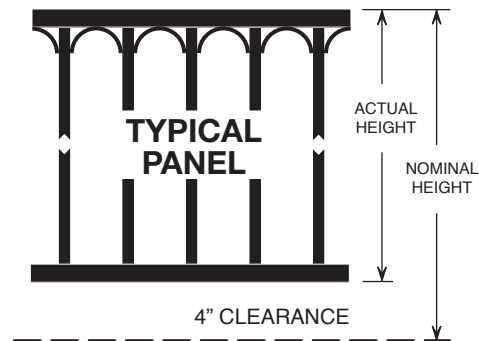

LIGHT EMPIRE, One Coat, Conventional Sizes

Panels

| | Nominal Height Actual Height | 3' 32" | 4' 44" | 5' 56" | 6' 68" |
|------------------------|---------------------------------|-----------|-----------|-----------|-----------|
| 94" length | Item Number | 75010-S | 75110-S | 75210-S | 75310-S |
| | Weight in Pounds | 38 | 46 | 54 | 62 |
| | Price | | | | |
| 120" length | Item Number | 75020-S | 75120-S | 75220-S | 75320-S |
| | Weight in Pounds | 49 | 59 | 69 | 79 |
| | Price | | | | |
| 143 1/2" length | Item Number | 75030-S | 75130-S | 75230-S | 75330-S |
| | Weight in Pounds | 58 | 70 | 82 | 90 |
| | Price | | | | |

Single Gates

Includes standard hardware: an "A-Kit" and an "M-Kit"

| | Nominal Height Actual Height | 3' 32" | 4' 44" | 5' 56" | 6' 68" |
|-------------------|---------------------------------|-----------|-----------|-----------|-----------|
| 3' opening | Item Number | 75409-S | 75419-S | 75429-S | 75439-S |
| | Weight in Pounds | 18 | 22 | 26 | 31 |
| | Price | | | | |
| 4' opening | Item Number | 75410-S | 75420-S | 75430-S | 75440-S |
| | Weight in Pounds | 21 | 26 | 31 | 36 |
| | Price | | | | |

Double Gates

Includes standard hardware: 2 "A-Kits" and an "R5-Kit"

| | Nominal Height Actual Height | 3' 32" | 4' 44" | 5' 56" | 6' 68" |
|--------------------|---------------------------------|-----------|-----------|-----------|-----------|
| 10' opening | Item Number | 75449-S | 75459-S | 75469-S | 75479-S |
| | Weight in Pounds | 56 | 68 | 81 | 94 |
| | Price | | | | |
| 12' opening | Item Number | 75450-S | 75460-S | 75470-S | 75480-S |
| | Weight in Pounds | 63 | 77 | 91 | 105 |
| | Price | | | | |

BFC Ornamental Iron

LIGHT EMPIRE
One Coat

LIGHT EMPIRE, One Coat, Non-Conventional Sizes

PANELS • Item # 75000-S

To determine prices for non-standard sizes, use this list of "per foot" prices.

| | | HEIGHT | | | | |
|----------|-----|--------|----|----|----|----|
| | | 2' | 3' | 4' | 5' | 6' |
| per foot | -XX | | | | | |

SINGLE GATES • Item # 75400-S

Single Gates include standard hardware: an "A-kit" and an "M-kit".

| | | HEIGHT | | | | |
|-------|-----|--------|----|----|----|----|
| | | 2' | 3' | 4' | 5' | 6' |
| WIDTH | 3' | | | | | |
| | 4' | | | | | |
| | 5' | | | | | |
| | 6' | | | | | |
| | 7' | | | | | |
| | 8' | | | | | |
| | 9' | | | | | |
| | 10' | | | | | |

DOUBLE GATES • Item # 75455-S

Double Gates include standard hardware: 2 "A-kits" and an "R5-kit".

| | | HEIGHT | | | | |
|-------|-----|--------|----|----|----|----|
| | | 2' | 3' | 4' | 5' | 6' |
| WIDTH | 6' | | | | | |
| | 8' | | | | | |
| | 10' | | | | | |
| | 12' | | | | | |
| | 14' | | | | | |
| | 16' | | | | | |
| | 18' | | | | | |
| | 20' | | | | | |

Prices are for rectangular fence and gates only.
For BIAS fence and gates, add \$ per lineal foot.
For TAPERED fence and gates, add \$ per lineal foot.

FOR CUSTOM OPTIONS: arching, scroll work or a wide variety of design alternatives, see the **SPECIAL PRICING APPLICATIONS** section of this catalog.

BFC Ornamental Iron

LIGHT MODERN
One Coat

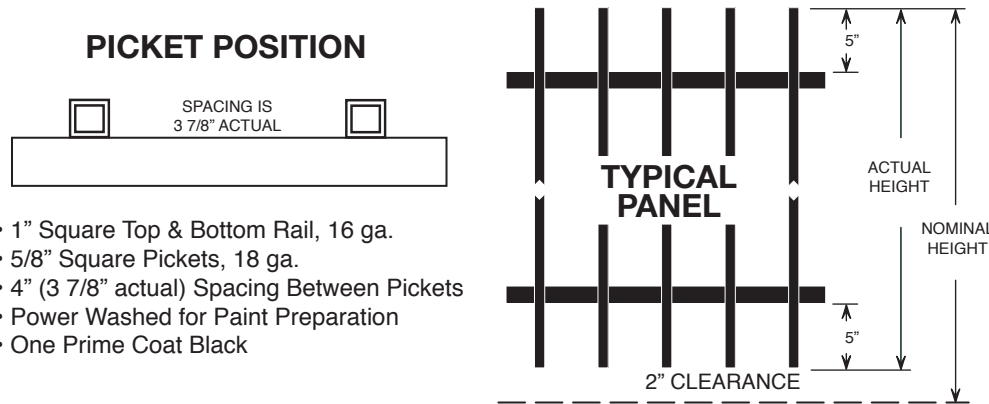

- 1" Square Top & Bottom Rail, 16 ga.
- 5/8" Square Pickets, 18 ga.
- 4" (3 7/8" actual) Spacing Between Pickets
- Power Washed for Paint Preparation
- One Prime Coat Black

BFC recommends that plastic plug caps be installed at both ends of open pickets. Add cents per foot. Caps shipped loose. Request when ordering.

LIGHT MODERN, One Coat, Conventional Sizes

Panels

| | Nominal Height Actual Height | 3' 34" | 4' 46" | 5' 58" | 6' 70" |
|------------------------|---------------------------------|-----------|-----------|-----------|-----------|
| 94" length | Item Number | 76010-S | 76110-S | 76210-S | 76310-S |
| | Weight in Pounds | 36 | 44 | 52 | 60 |
| 120" length | Item Number | 76020-S | 76120-S | 76220-S | 76320-S |
| | Weight in Pounds | 46 | 56 | 66 | 76 |
| 143 1/2" length | Item Number | 76030-S | 76130-S | 76230-S | 76330-S |
| | Weight in Pounds | 54 | 66 | 78 | 90 |
| | Price | | | | |

Single Gates

Includes standard hardware: an "A-Kit" and an "M-Kit"

| | Nominal Height Actual Height | 3' 34" | 4' 46" | 5' 58" | 6' 70" |
|-------------------|---------------------------------|-----------|-----------|-----------|-----------|
| 3' opening | Item Number | 76409-S | 76419-S | 76429-S | 76439-S |
| | Weight in Pounds | 17 | 21 | 25 | 30 |
| 4' opening | Item Number | 76410-S | 76420-S | 76430-S | 76440-S |
| | Weight in Pounds | 20 | 25 | 30 | 35 |
| | Price | | | | |

Double Gates

Includes standard hardware: 2 "A-Kits" and an "R5-Kit"

| | Nominal Height Actual Height | 3' 34" | 4' 46" | 5' 58" | 6' 70" |
|--------------------|---------------------------------|-----------|-----------|-----------|-----------|
| 10' opening | Item Number | 76449-S | 76459-S | 76469-S | 76479-S |
| | Weight in Pounds | 53 | 66 | 79 | 92 |
| 12' opening | Item Number | 76450-S | 76460-S | 76470-S | 76480-S |
| | Weight in Pounds | 60 | 74 | 88 | 102 |
| | Price | | | | |

BFC Ornamental Iron

LIGHT MODERN
One Coat

LIGHT MODERN, One Coat, Non-Conventional Sizes

PANELS • Item # 76000-S

To determine prices for non-standard sizes, use this list of "per foot" prices.

| | | HEIGHT | | | | |
|----------|-----|--------|----|----|----|----|
| | | 2' | 3' | 4' | 5' | 6' |
| per foot | -XX | | | | | |
| | | | | | | |

SINGLE GATES • Item # 76400-S

Single Gates include standard hardware: an "A-kit" and an "M-kit".

| | | HEIGHT | | | | |
|-------|-----|--------|----|----|----|----|
| | | 2' | 3' | 4' | 5' | 6' |
| WIDTH | 3' | | | | | |
| | 4' | | | | | |
| | 5' | | | | | |
| | 6' | | | | | |
| | 7' | | | | | |
| | 8' | | | | | |
| | 9' | | | | | |
| | 10' | | | | | |

DOUBLE GATES • Item # 76455-S

Double Gates include standard hardware: 2 "A-kits" and an "R5-kit".

| | | HEIGHT | | | | |
|-------|-----|--------|----|----|----|----|
| | | 2' | 3' | 4' | 5' | 6' |
| WIDTH | 6' | | | | | |
| | 8' | | | | | |
| | 10' | | | | | |
| | 12' | | | | | |
| | 14' | | | | | |
| | 16' | | | | | |
| | 18' | | | | | |
| | 20' | | | | | |

Prices are for rectangular fence and gates only.
For BIAS fence and gates, add \$ per lineal foot.
For TAPERED fence and gates, add \$ per lineal foot.

FOR CUSTOM OPTIONS: arching, scroll work or a wide variety of design alternatives, see the **SPECIAL PRICING APPLICATIONS** section of this catalog.

BFC Ornamental Iron LIGHT REGAL PANELS Biasable, One Coat

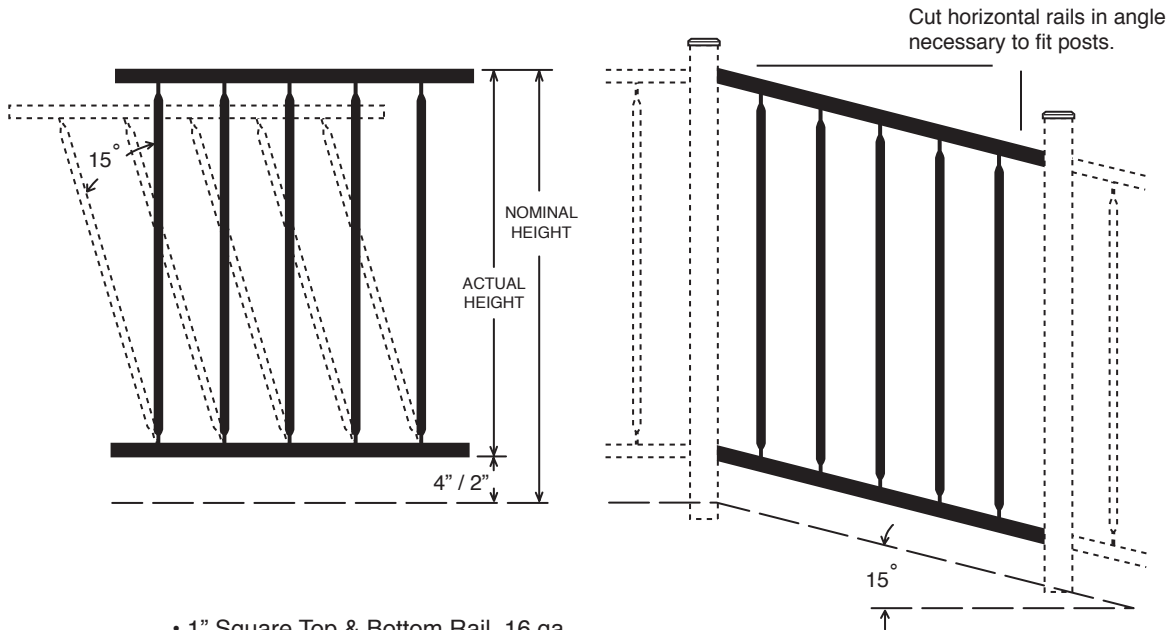

- 1" Square Top & Bottom Rail, 16 ga.
- 5/8" Square Pickets, 18 ga.
- 4" (3 7/8" actual) Spacing Between Pickets
- Power Washed for Paint Preparation
- One Prime Coat Black

LIGHT REGAL PANELS, Biasable, One Coat

| Nominal Height Actual Height | HEIGHT | | | | | |
|---------------------------------|-----------|---------------|-----------|-----------|----------------|-----------|
| | 3' 32" | 3 1/2' 38" | 4' 44" | 5' 56" | SPECIAL 58" | 6' 68" |
| Net LENGTH | | | | | | |
| Item Number 94" | 77010-S | 77041-S | 77110-S | 77210-S | 77240-S | 77310-S |
| Item Number 120" | 77020-S | 77042-S | 77120-S | 77220-S | 77250-S | 77320-S |
| Item Number 143 1/2" | 77030-S | 77043-S | 77130-S | 77230-S | 77260-S | 77330-S |

TRASH ENCLOSURE DOUBLE GATES

Height

5 ft & 6 ft

Opening

up to 9 ft & up to 12 ft

✦
Optional jambs
shown, see below
for pricing

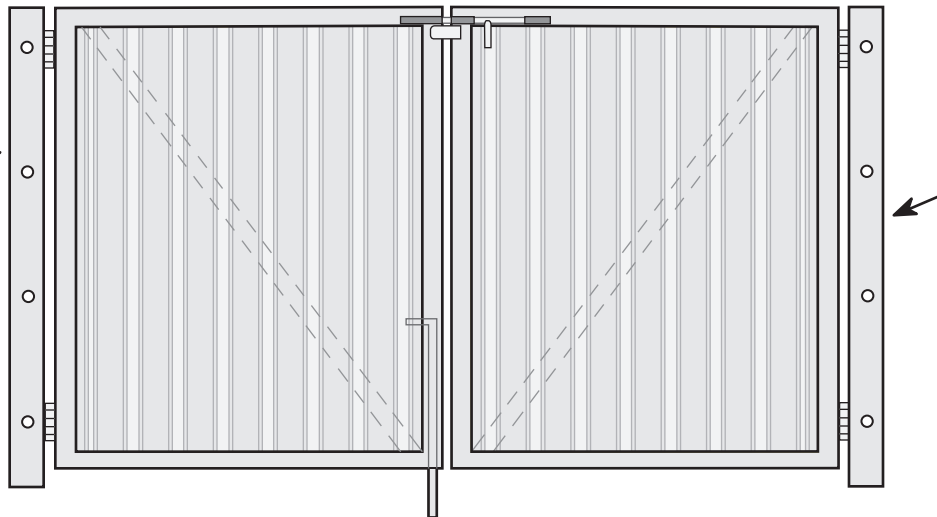

Gates are manufactured with 1/4" x 2" x 2" angle frames, 1/4" x 2" flat bar diagonal bracing, 20 GA galvanized decking, factory installed 4 x 4 butt hinges, heavy drop rod and slide bolt. Gates are shipped with one coat high solids primer only.

| Item # | Height | Opening | Price |
|-----------|--------|-------------|-------|
| 81350-108 | 5' | 9' or less | |
| 81350-144 | 5' | 12' or less | |
| 81360-108 | 6' | 9' or less | |
| 81360-144 | 6' | 12' or less | |

For optional top coat of polyurethane (furnish color sample) add \$ _____ per set.
(Touch-up paint included.)

✦ For optional 3" channel jamb or 4" angle jamb, welded to the gate hinges, with (4) mounting holes furnished add \$ _____ per set.

BOTTOM TRACK CANTILEVER GATE SYSTEM

Heavy Regal

For pricing system components only see page 7 in Rolling Gate Hardware.

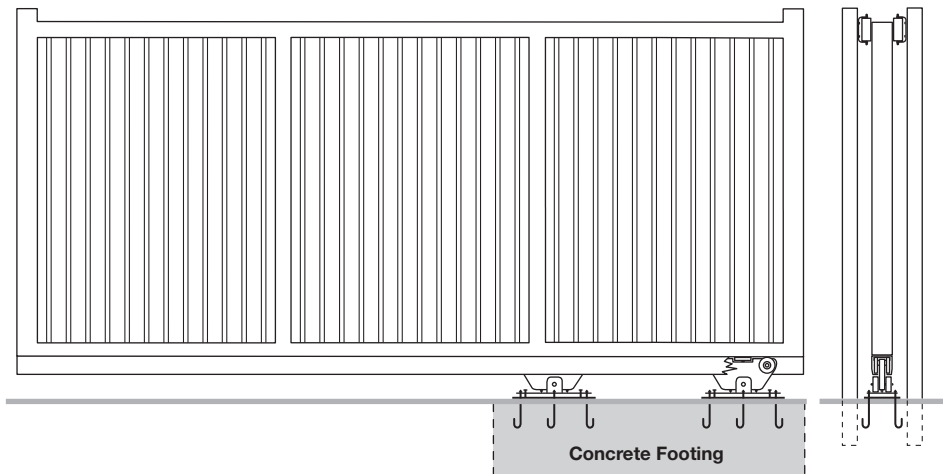

Each Gate Requires

- 1 or more Cantilever Bottom Track *
- 2 ea. Cantilever Gate Trolley
- 2 ea. (Optional) Trolley Ground Plate
- 12 ea. Hook Bolts
- 2 ea. Receiver Cup
- 2 ea. End Wheel Cap
- 2 ea. BFC Type II (O.H. roller set)

* 236" long track sold in FULL LENGTHS ONLY.
33 foot maximum opening,
2,200 lb. maximum total weight,
All items are galvanized.

Heavy Aristocrat

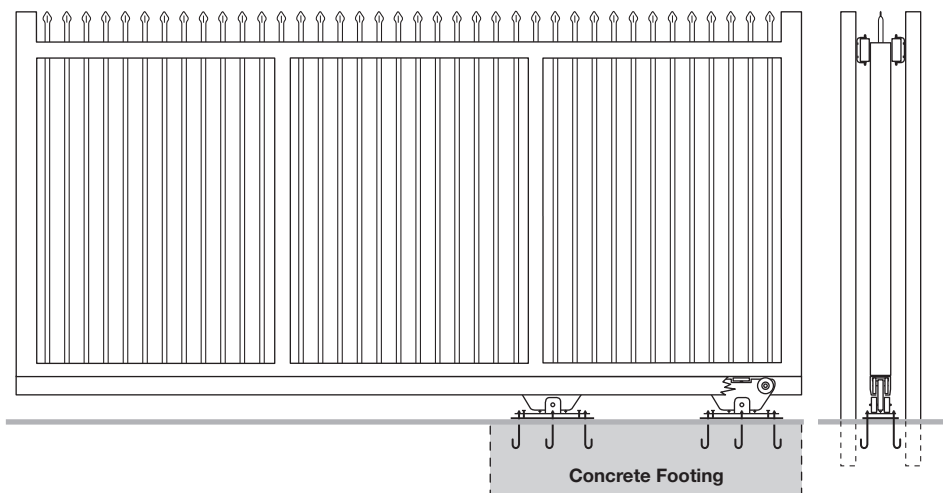

Heavy Guardian

For heavier gates, call for quotation.

